

# PREVOST

## Pneumatic diagram

*PNEUMATIC DIAGRAMS X3-45 COACHES WITH INDEPENDENT SUSP.*

NO:	<b>D140330 P0</b>	REVISION :	<b>Q</b>
-----	-------------------	------------	----------

EFF. OC#	2004015	PRIOR TO OC#	<b>2007131 &amp; 2009088</b>
EFF. VEH#	#7-8933	PRIOR TO VEH#	<b>#A-9953</b>

DR.	Y. Laine	date	2010-06-22
CHK	Marc-Jose Handfield	appr	Marc-José Handfield

REV.	DATE	DESCRIPTION	PAGE	BY	CHK.	APPR.	
A	2005-06-01	#6-8754 X3-45 PROTOTYPE VEHICLE					
	2005-09-01	#6-8821 X3-45 PRELIMINARY VEHICLE #1					
	2005-10-18	#6-8863 X3-45 PRELIMINARY VEHICLE #2					
	2005-11-24	#7-8883 X3-45 PRELIMINARY VEHICLE #3					
	2006-03-07	X3-45 PRODUCTION VEHICLE (HAMPTON JITNEY) #7-8933...					
B	2006-07-14	#D140330SP3 (SPECIAL ORLEANS) Revision : B	SP3	Rob.	M.J.H.	M.J.H.	
	2006-07-14	#D140330SP1 (SPECIAL WABCO AIR DRYER) Revision : B	SP1	Rob.	M.J.H.	M.J.H.	
	2006-07-14	#D140330SP1 (SPECIAL WABCO AIR DRYER) Revision : C	SP1	Rob.	M.J.H.	M.J.H.	
	2006-08-22	#D140330 P1.0 REVISION : B	P1.0	Rob.	M.J.H.	M.J.H.	
	2006-08-22	#D140330 P1.1 REVISION : B	P1.1	Rob.	M.J.H.	M.J.H.	
	2006-08-22	#D140330 P1.2 REVISION : B	P1.2	Rob.	M.J.H.	M.J.H.	
	2006-08-22	#D140330 P1.3 REVISION : B	P1.3	Rob.	M.J.H.	M.J.H.	
	2006-08-22	#D140330 P1.4 REVISION : B	P1.4	Rob.	M.J.H.	M.J.H.	
	C	2007-04-13	#D140330 P1.0 REVISION: C (E-Rides valves Replaced)	P1.0	Rob.	M.J.H.	M.J.H.
			#D140330 P1.1 REVISION: C (E-Rides valves Replaced)	P1.1	Rob.	M.J.H.	M.J.H.
		#D140330 P1.2 REVISION: C (E-Rides valves Replaced)	P1.2	Rob.	M.J.H.	M.J.H.	
		#D140330 P1.3 REVISION: C (E-Rides valves Replaced)	P1.3	Rob.	M.J.H.	M.J.H.	
		#D140330 P1.4 REVISION: C (E-Rides valves Replaced)	P1.4	Rob.	M.J.H.	M.J.H.	
		#D140330 P2.0 REVISION: B (E-Rides valves Replaced)	P2.0	Rob.	M.J.H.	M.J.H.	
		#D140330 P3.0 REVISION: B (E-Rides valves Replaced)	P3.0	Rob.	M.J.H.	M.J.H.	
		#D140330 P4.0 REVISION: B (E-Rides valves Replaced) PRODUCTION VEHICLE #8-9226... O.C.#2007020	P4.0	Rob.	M.J.H.	M.J.H.	

# PREVOST

## Pneumatic diagram

### *PNEUMATIC DIAGRAMS X3-45 COACHES WITH INDEPENDENT SUSP.*

REV.	DATE	DESCRIPTION	PAGE	BY	CHK.	APPR.
D	2007-05	#D140330 P1.0 REVISION: D (ABS 6)	P1.0	Rob.	M.J.H.	M.J.H.
		#D140330 P1.1 REVISION: D (ABS 6)	P1.1	Rob.	M.J.H.	M.J.H.
		#D140330 P1.2 REVISION: D (ABS 6)	P1.2	Rob.	M.J.H.	M.J.H.
		#D140330 P1.3 REVISION: D (ABS 6)	P1.3	Rob.	M.J.H.	M.J.H.
		#D140330 P1.4 REVISION: D (ABS 6)	P1.4	Rob.	M.J.H.	M.J.H.
		#D140330 P2.0 REVISION: C (ABS 6 & ESP)	P2.0 & 2.1	Rob.	M.J.H.	M.J.H.
		#D140330 P3.0 REVISION: C (ABS 6 & ESP)	P3.0 & 3.1	Rob.	M.J.H.	M.J.H.
		#D140330 P4.0 REVISION: C (ABS 6 & ESP)	P4.0 & 4.1	Rob.	M.J.H.	M.J.H.
		#D140330 P7.0 REVISION: B (ESP)	P7.0 & 7.1	Rob.	M.J.H.	M.J.H.
		#D140330 P8.0 REVISION: B (ABS 6)	P8.0 & 8.1	Rob.	M.J.H.	M.J.H.
		#D140330 P9.0 REVISION: A (ESP)	P9.0 & 9.1	Rob.	M.J.H.	M.J.H.
		#D140330 P10.0 REVISION: A (ESP)	P10.0&10.1	Rob.	M.J.H.	M.J.H.
		#D140330 SP1.0 REVISION: C (Update)	SP1.0&1.1	Rob.	M.J.H.	M.J.H.
		#D140330 SP2.0 REVISION: B (ESP)	SP2.0&2.1	Rob.	M.J.H.	M.J.H.
			2007-05-25	#8-9259 X3-45 PRELIMINARY VEHICLE ESP		
	2007-06-25	PRODUCTION VEHICLE ESP (X3-45 ORLEANS) #8-9288...				
E	2007-12-05	#D140330 P1.0 REVISION: E	P1.0	Rob.	M.J.H.	M.J.H.
		#D140330 P1.1 REVISION: E	P1.1	Rob.	M.J.H.	M.J.H.
		#D140330 P1.2 REVISION: E	P1.2	Rob.	M.J.H.	M.J.H.
		#D140330 P1.3 REVISION: E	P1.3	Rob.	M.J.H.	M.J.H.
		#D140330 P1.4 REVISION: E	P1.4	Rob.	M.J.H.	M.J.H.
		VEHICLES #8-9405 , #8-9431 , PRODUCTION #8-9426...				
F	2008-02-26	ENGINE VOLVO MD13		Rob.	M.J.H.	M.J.H.
		Preliminary vehicles : No. 1 #8-9259 , No.2 #8-9295 , No.3 #8-9364		Rob.	M.J.H.	M.J.H.
		PRODUCTION VEHICLE X3-45 : #8-9451...				
		New page #D140330P11	P11&11.1	Rob.	M.J.H.	M.J.H.
		New page #D140330SP4	SP4&4.1	Rob.	M.J.H.	M.J.H.
G	2008-03-26	X3-45 COACH IFS WITH SPECIAL FAST FRONT KNEELING NEW PAGE #D140330SP5	SP5&SP5.1	Rob.	M.J.H.	M.J.H.
H	2008-04-04	NEW AIR HORN , SEE #D140330 P.1 REVISION : F EFFECTIF PRODUCTION VEHICLE :#8-9422...	P1.0 TO 1.4	Rob.	M.J.H.	M.J.H.
I	2008-04-14	#D140330 P7.0 REVISION: C (Update)	P7.0 & 7.1	Rob.	M.J.H.	M.J.H.
		#D140330 P9.0 REVISION: B (Update)	P9.0 & 9.1	Rob.	M.J.H.	M.J.H.
		#D140330 P10.0 REVISION: B (Update)	P10.0&10.1	Rob.	M.J.H.	M.J.H.
		#D140330 SP2.0 REVISION: C (Update)	SP2.0&2.1	Rob.	M.J.H.	M.J.H.

# Pneumatic diagram

## *PNEUMATIC DIAGRAMS X3-45 COACHES WITH INDEPENDENT SUSP.*

REV.	DATE	DESCRIPTION	PAGE	BY	CHK.	APPR.
J	2008-04-17	NEW AIR TANK REAR SUB-FRAME SUSPENSION AND R-14 VALVE #D140330P2, P3, P4, update, Rev D	P2 & 2.1 P3 & 3.1 P4 & 4.1	Y.L. Y.L. Y.L.	M.J.H. M.J.H. M.J.H.	M.J.H. M.J.H. M.J.H.
K	2008-01-11	NEW AIR TANKS ASSY FOR DIFFERENTIAL AIR BELLOWS SUSPENSION. #D140330 P.1 , P.2 , P.3 , P.4	P1 TO P4 P1.1 TO P4.1	Rob.	M.J.H.	M.J.H.
L	2008-06-27	D13 VOLVO ENGINE , ADD AIR CLEANER INJECTOR #D140330 P12 & P13 NEW PAGES. <b>RETROFIT PRIOR TO #8-9451 EFFECTIVE VEHICLE #9-9614...</b>	P12.1 P13.1	Y.L.	M.J.H.	M.J.H.
M	2008-07-08 2008-07-15	UPDATE P7 & SP2 AIR BRAKE TRAILER HITCH COST SAVING , O.C.#2008069 , Effective Vehicle #9-9599 ... #D140330 P1.0 REVISION: H #D140330 P2.0 REVISION: E #D140330 P3.0 REVISION: E #D140330 P4.0 REVISION: E	P7 & SP2  P1.0 & 1.1 P2.0 & 2.1 P3.0&3.1 P4.0&4.1	Y.L.  Rob. Rob. Rob. Rob.	M.J.H.  M.J.H. M.J.H. M.J.H. M.J.H.	M.J.H.  M.J.H. M.J.H. M.J.H. M.J.H.
N	2008-12-04	#D140330 SP7 ADD NEW PAGE FOR GREYHOUND BOLT BUS	P7.0&7.1	Rob.	M.J.H.	M.J.H.
O	2009-01-14	#D140330 P7.0 REV.E & SP2.0 REV. E SEE O.C.#2008107	P7.0 & SP2.0	Rob.	M.J.H.	M.J.H.
P	2010-04-28	NEW TAG AXLE, O.C. #2007131 (Preliminary vehicles: #A-9872, #A-9907, #A-9926) EFFECTIVE VEHICLE #A-9953	   P1.0 & 1.1 P2.0 & 2.1 P3.0 & 3.1 P4.0 & 4.1 P7.0 & 7.1 P8 & P8.1 P9.0 & P9.1 P10.0&P10.1 P11.0&P11.1 P12.0&P12.1 P13.0&P13.1 P14.0&P14.1 NEW PAGE P14.0&P14.1 SP1.0&SP1.1 SP2.0&SP2.1 SP4.0&SP4.1 NEW PAGE SP6.0&SP6.1 SP7.0&SP7.1 P10 & 10.1	   Y.L.	   M.J.H.	   M.J.H.
Q	2010-04-28	UPDATE				

## Pneumatic diagram

*PNEUMATIC DIAGRAMS X3-45 COACHES WITH INDEPENDENT SUSP.*

PRODUCTION NUMBER	REV	EFF. VEH.	ECN	S.A.V. NUMBER	REV	DESCRIPTION
D140330P1.0	A	#7-8933	2004015	D140330P1.1	I	FULL PNEUMATIC SYSTEM ABS 6
	B	#7-9035	----	D140330P1.2	I	ACCESSORIES
	C	#8-9226	2007020	D140330P1.3	I	BRAKES SYSTEM
	D	#8-9282	2006038 2005002	D140330P1.4	I	SUSPENSION
	E	#8-9426	----			
	F	#8-9426	2006025			
	G	#9-9504	2007108			
	H	#9-9599	2008069			
	I	#A-9953	2007131			
D140330P2.0	A	#7-8933	2004015	D140330P2.1	A	KNEELING & LOW-BUOY OPTION
	B	#8-9226	2007020		B	
	C	#8-9288	2006038&2005002		C	
	D	#9-9504	2007108		D	
	E	#9-9599	2008069		E	
	F	#A-9953	2007131		F	
D140330P3.0	A	#7-8933	2004015	D140330P3.1	A	KNEELING & HIGH-BUOY OPTION
	B	#8-9226	2007020		B	
	C	#8-9288	2006038&2005002		C	
	D	#9-9504	2007108		D	
	E	#9-9599	2008069		E	
	F	#A-9953	2007131		F	
D140330P4.0	A	#7-8933	2004015	D140330P4.1	A	KNEELING, LOW-BUOY & HIGH-BUOY OPTION
	B	#8-9226	2007020		B	
	C	#8-9288	2006038&2005002		C	
	D	#9-9504	2007108		D	
	E	#9-9599	2008069		E	
	F	#A-9953	2007131		F	
D140330P5.0	A	#7-8933	2004015	D140330P5.1	A	KNEELING OPTION
D140330P6.0	A	#7-8933	2004015	D140330P6.1	A	PARKING BRAKE WITH WCL WITHOUT KNEELING OPTION
D140330P7.0	A	#7-8933	2004015	D140330P7.1	A	TRAILER HITCH AIR BRAKE OPTION (Allison transmission) AND



## Pneumatic diagram

*PNEUMATIC DIAGRAMS X3-45 COACHES WITH INDEPENDENT SUSP.*

PRODUCTION NUMBER	REV	EFF. VEH.	ECN	S.A.V. NUMBER	REV	DESCRIPTION
	B	#8-9288	2006038 2005002		B	ABS 6 OR SYSTEM ESP OPTION
	C	---	---		C	
	D	---	---		D	
	E	#9-9674	2008107		E	
	F	#A-9953	2007131		F	
D140330P8.0	A	#7-8933	2004015	D140330P8.1	A	WITH ZF TRANSMISSION OPTION ABS 6( HALDEX AIR DRYER )
	B	#8-9288	2006038 2005002		B	
	C	#A-9953	2007131		C	
D140330P9.0	A	#8-9288	2006038 2005002	D140330P9.1	A	ZF TRANSMISSION OPTION SYSTEM ESP OPTION ( HALDEX AIR DRYER )
	B				B	
	C	#A-9953	2007131		C	
D140330P10.0	A	#8-9288	2006038 2005002	D140330P10.1	A	BRAKE SYSTEM ESP (Electronic Stability Program) OPTION
	B				B	
	C	#A-9953	2007131		C	
	D				D	
D140330P11.0	A	#8-9451	2005086	D140330P11.1	A	MD 13 VOLVO ENGINE WITH HALDEX AIR DRYER INTO LUGGAGE COMPARTMENT
	B	#A-9953	2007131		B	
D140330P12.0	A	#8-9451	2008048	D140330P12.1	A	D13 VOLVO ENGINE WITH RETARDER, ALLISON TRANSM.
	B	#A-9953	2009088		B	
D140330P13.0	A	#8-9451	2008048	D140330P13.1	A	D13 VOLVO ENGINE WITHOUT RETARDER, ALLISON TRANSM.
	B	#A-9953	2009088		B	
D140330P14.0	A	#8-9282	2006038	D140330P14.1	A	S60 ENGINE WITH OUTPUT RETARDER, ALLISON TRANSM.
	B	#A-9953	2009088		B	
D140330P15.0	A	#A-9953	2007131	D140330P15.1	A	S60 ENGINE HALDEX AIR DRYER REAR SUB FRAME OPTION
D140330P16.0	A	?	2007131	D140330P16.1	A	D13 VOLVO ENGINE WABCO AIR DRYER INTO LUGGAGE COMPARTMENT

# Pneumatic diagram

*PNEUMATIC DIAGRAMS X3-45 COACHES WITH INDEPENDENT SUSP.*

D140330SP1.0	A B C <b>D</b>	#7-8952 #7-8883 #8-9288 <b>#A-9953</b>	---- 2004015 2006038 <b>2007131</b>	D140330SP1.1	A B C <b>D</b>	“SPECIAL” WITH WABCO AIR DRYER INTO REAR SUB-FRAME AND ENGINE DETROIT S-60
D140330SP2.0	A B C D E <b>F</b>	#7-8933 #8-9288 ---- ---- #9-9674 <b>#A-9953</b>	2004015 2006038 2005002 ---- 2008107 <b>2007131</b>	D140330SP2.1	A B C D E <b>F</b>	“SPECIAL” WITH TRAILER, ZF TRANSMISSION AND BRAKE SYSTEM ESP OPTION
D140330SP3.0	A <b>B</b>	#7-8952 ----	2004015 ----	D140330SP3.1	A <b>B</b>	“SPECIAL” WITH OPTION PARKING BRAKE RELEASE WITH SUPPLEMENTARY SWITCH / WHITOUT KNEELING (ORLEANS)
D140330SP4.0	A <b>B</b>	#9-9451 <b>#A-9953</b>	---- <b>2007131</b>	D140330SP4.1	A <b>B</b>	“SPECIAL” WITH WABCO AIR DRYER INTO LUGGAGE COMPARTMENT AND ENGINE DETROIT S-60
D140330SP5.0	<b>A</b>	<b>#9-9451</b> <b>#9-9520</b>	----	D140330SP5.1	<b>A</b>	“SPECIAL” WITH FAST FRONT KNEELING
D140330SP6.0	<b>A</b>	<b>#A-9953</b>	<b>2007131</b>	D140330SP6.0	<b>A</b>	“SPECIAL” WITH WABCO AIR DRYER INTO LUGGAGE COMPARTMENT AND ENGINE VOLVO D13
D140330SP7.0	A <b>B</b>	#9-9643 <b>#A-9953</b>	---- <b>2007131</b>	D140330SP7.1	A <b>B</b>	“SPECIAL” DETROIT ENGINE WITH HALDEX AIR DRYER ON LUGGAGE COMPARTMENT ( GREYHOUND BOLT BUS )

NOTES: 1) WITH OUTPUT RETARDER ON WORLD AUTOMATIC TRANSMISSION

ACTIVE	COLOR	CIRCUIT
---	RED	SECONDARY
---	GREEN	PRIMARY & SUPPLY
---	YELLOW	PARKING BRAKES
---	BLUE	STANDARD SUSPENSION
---	BLACK	ACCESSORIES

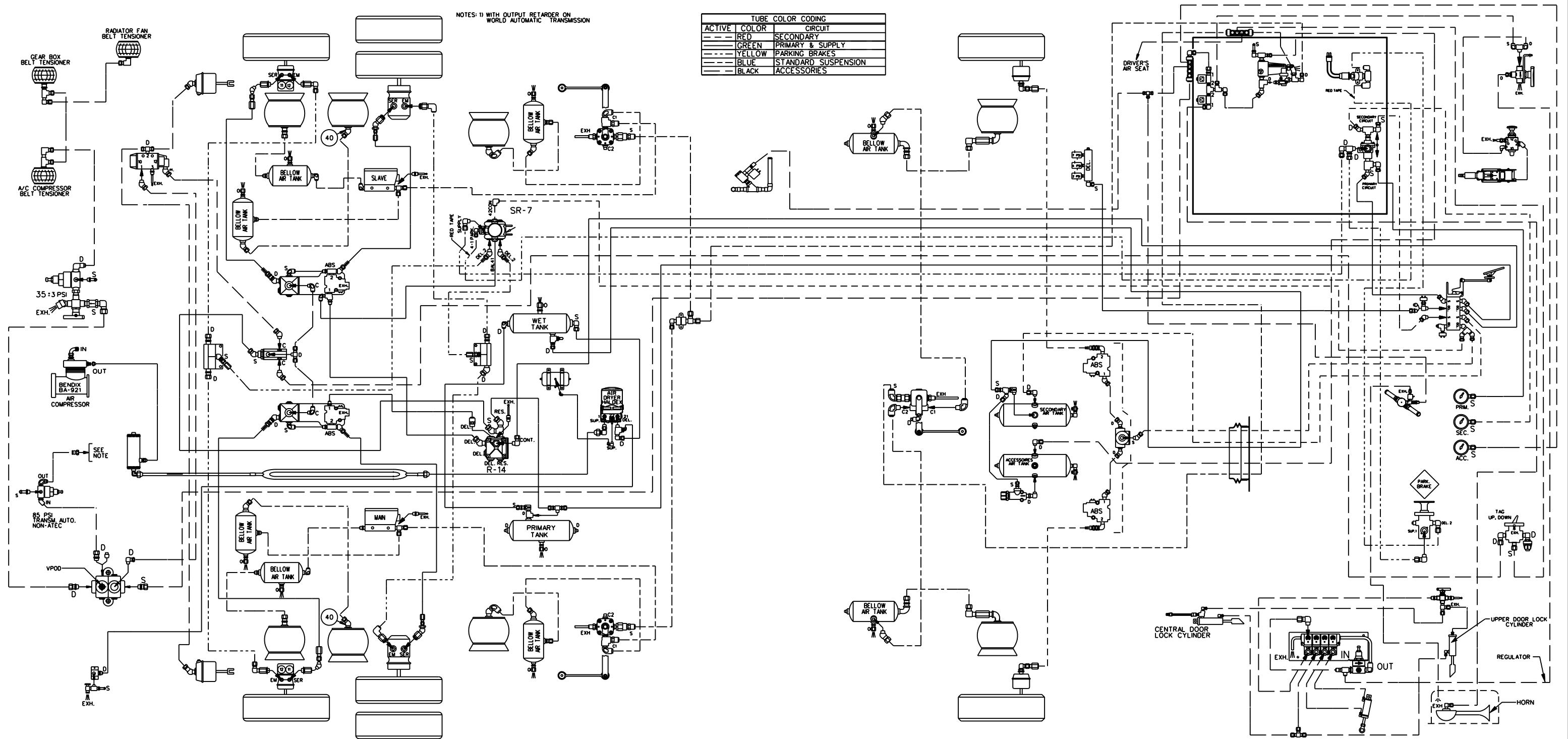

**PREVOST**

DESCRIPTION:  
X3-45 COACH, WITH INDEPENDENT FRONT SUSPENSION (I.F.S.)  
FULL PNEUMATIC SYSTEM

EFF. W/ VEH : #7-8933...  
DATE: 2006/03 REV.: A

PAGE:  
D140330 P1.1

NOTES: 1) WITH OUTPUT RETARDER ON WORLD AUTOMATIC TRANSMISSION

ACTIVE	COLOR	CIRCUIT
---	RED	SECONDARY
---	GREEN	PRIMARY & SUPPLY
---	YELLOW	PARKING BRAKES
---	BLUE	STANDARD SUSPENSION
---	BLACK	ACCESSORIES

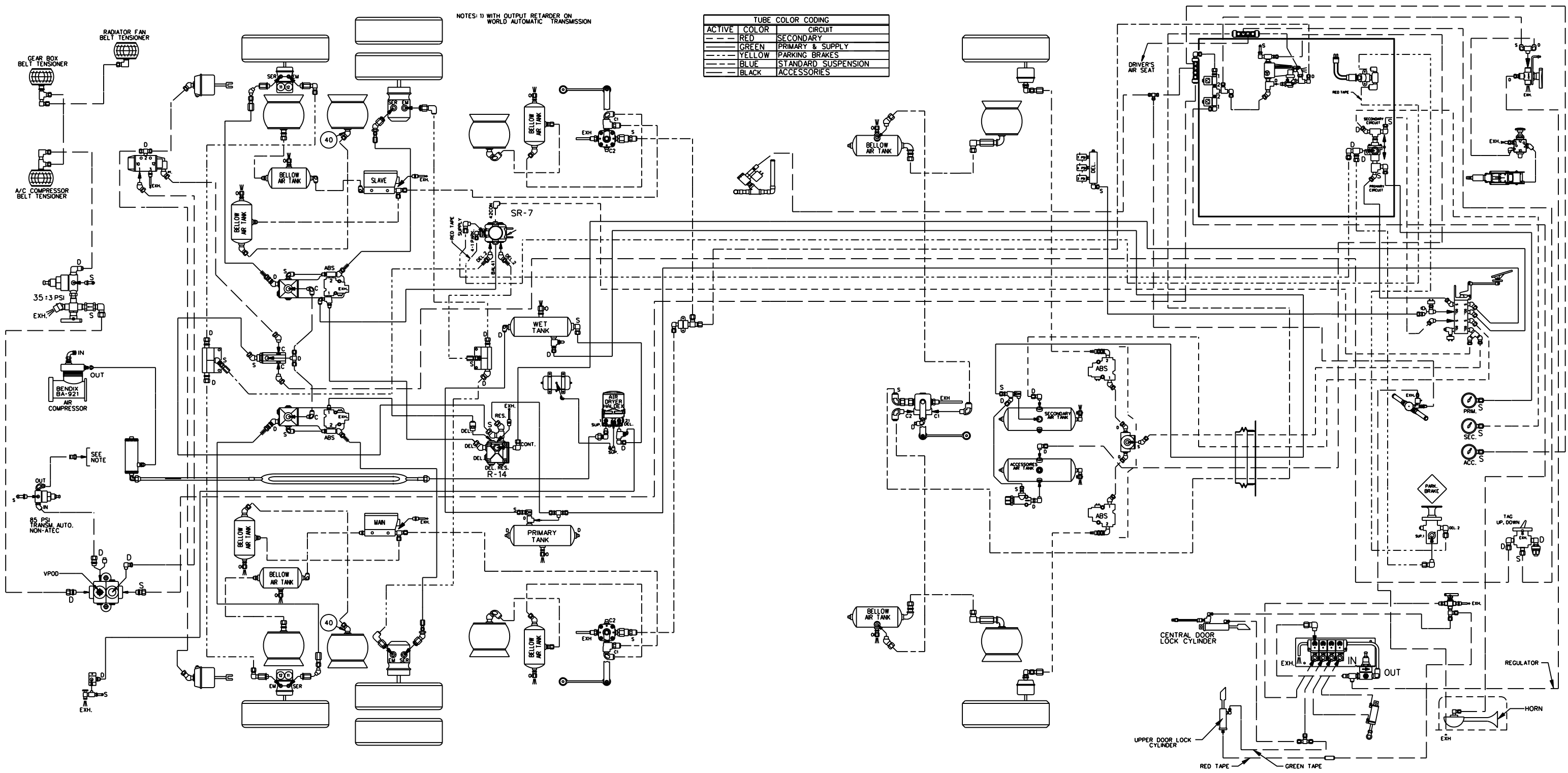

**PREVOST**

DESCRIPTION:  
X3-45 COACH, WITH INDEPENDENT FRONT SUSPENSION (I.F.S.)  
FULL PNEUMATIC SYSTEM

EFF. W/ VEH : #7-9035...  
DATE: 2006/08 REV.: B

PAGE:  
D140330 P1.1

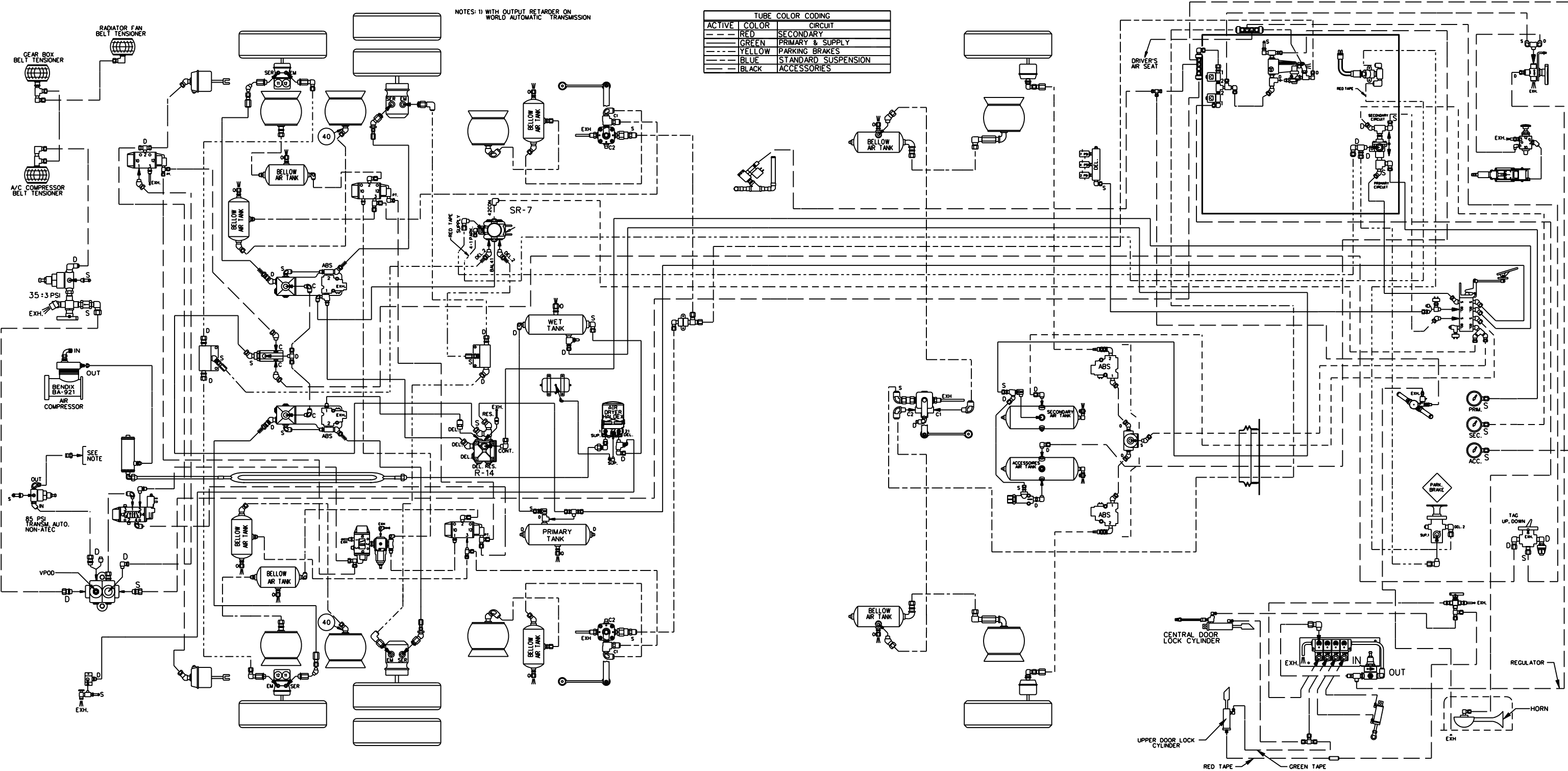

**PREVOST**®

DESCRIPTION:  
X3-45 COACH, WITH INDEPENDENT FRONT SUSPENSION (I.F.S.)  
FULL PNEUMATIC SYSTEM

EFF. W/ VEH : #8-9226...  
DATE: 2007/04 REV.: C

PAGE:  
D140330 P.1

NOTES: 1) WITH OUTPUT RETARDER ON  
WORLD AUTOMATIC TRANSMISSION

ACTIVE	COLOR	CIRCUIT
---	RED	SECONDARY
---	GREEN	PRIMARY & SUPPLY
---	YELLOW	PARKING BRAKES
---	BLUE	STANDARD SUSPENSION
---	BLACK	ACCESSORIES

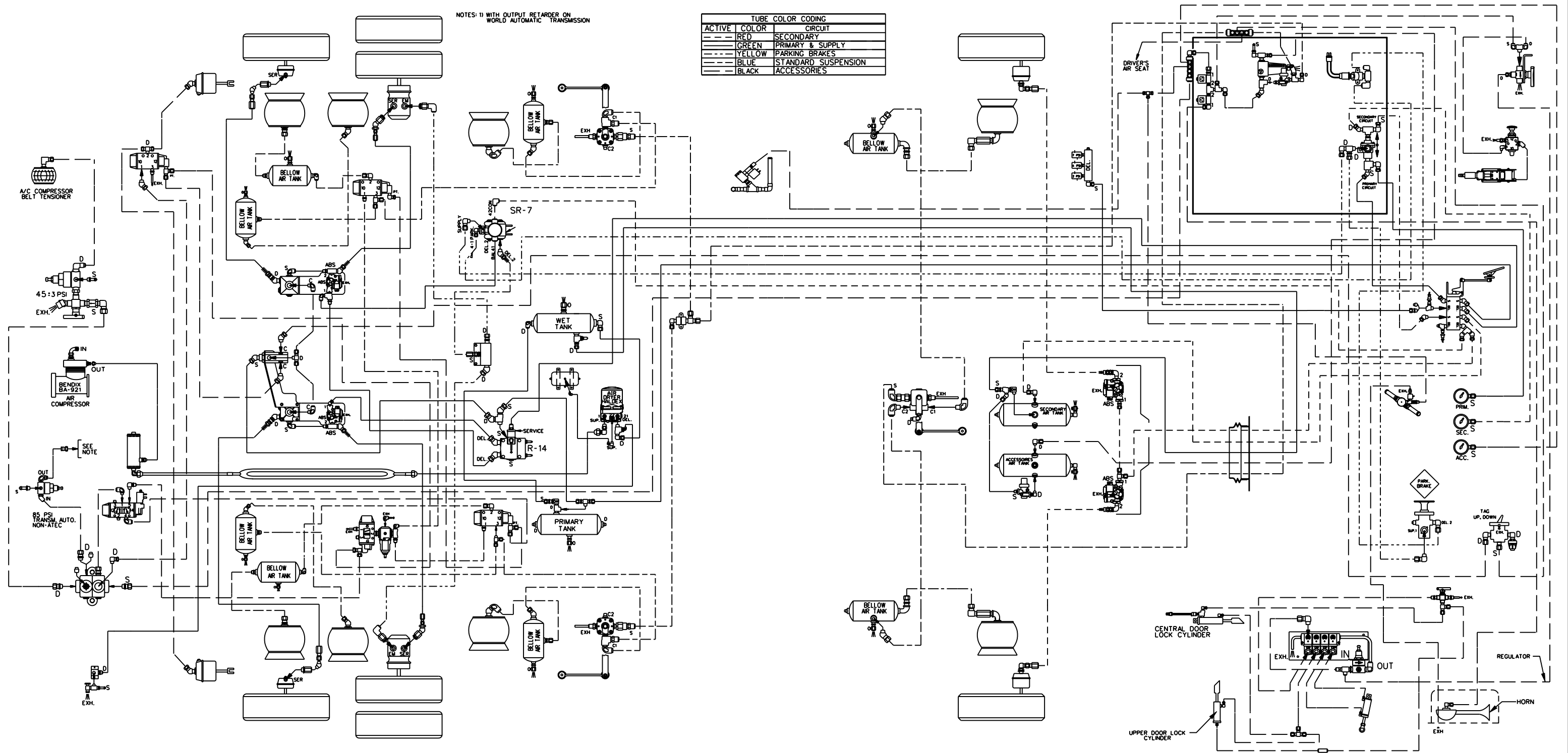

**PREVOST®**

DESCRIPTION:  
X3-45 COACH, WITH INDEPENDENT FRONT SUSPENSION (I.F.S.)  
FULL PNEUMATIC SYSTEM

EFF. W/ VEH : #8-9295...  
DATE: 2007/07 REV.: D

PAGE:  
D140330 P1.1

NOTES: 1) WITH OUTPUT RETARDER ON WORLD AUTOMATIC TRANSMISSION

ACTIVE	COLOR	CIRCUIT
---	RED	SECONDARY
---	GREEN	PRIMARY & SUPPLY
---	YELLOW	PARKING BRAKES
---	BLUE	STANDARD SUSPENSION
---	BLACK	ACCESSORIES

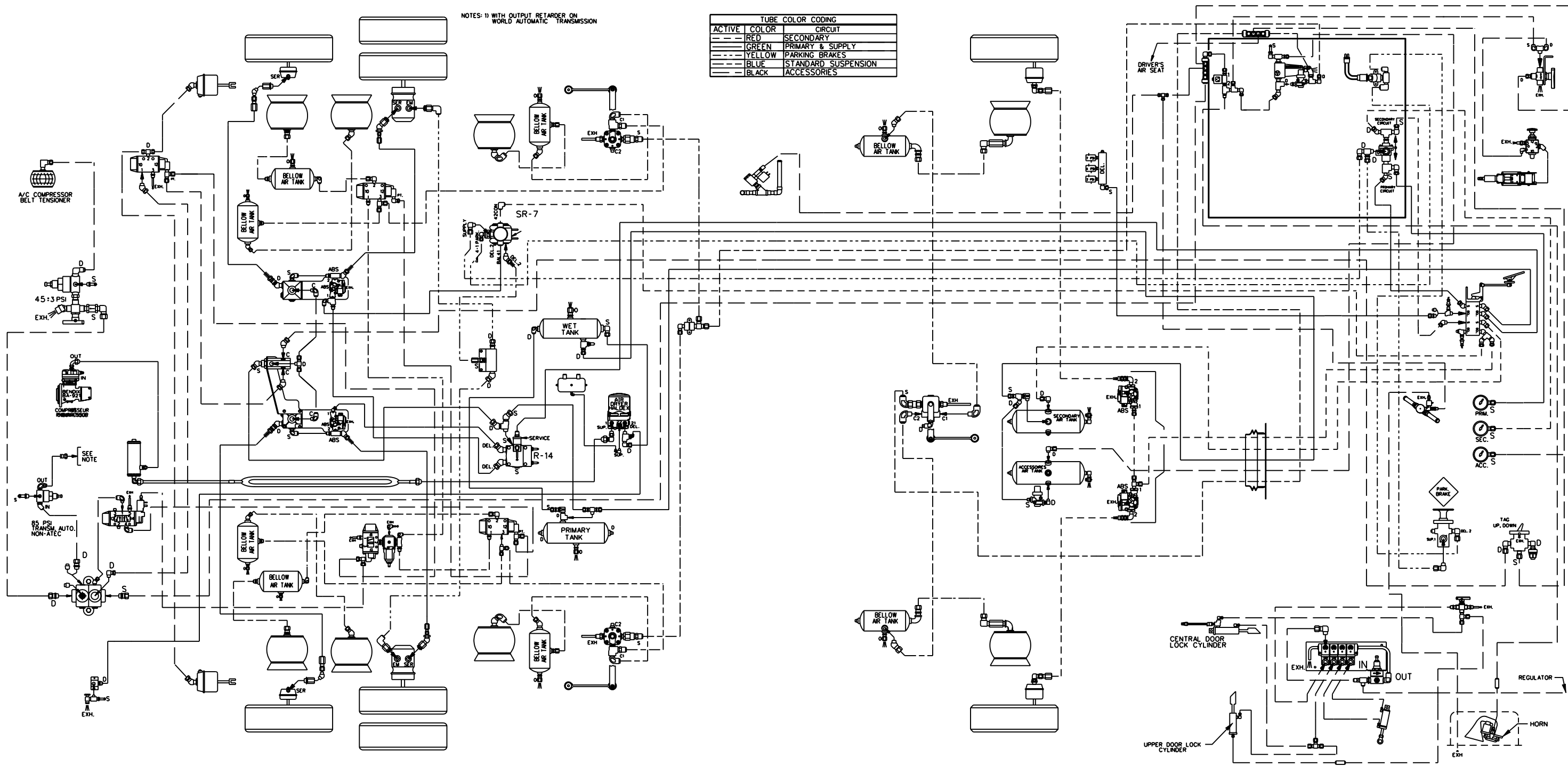

**PREVOST**®

DESCRIPTION:  
X3-45 COACH, WITH INDEPENDENT FRONT SUSPENSION (I.F.S.)  
FULL PNEUMATIC SYSTEM

EFF. W/ VEH : #8-9422...  
DATE: 2008/03 REV.: F

PAGE:  
D140330 P.1

NOTES: 1) WITH OUTPUT RETARDER ON  
WORLD AUTOMATIC TRANSMISSION

ACTIVE	COLOR	CIRCUIT
---	RED	SECONDARY
---	GREEN	PRIMARY & SUPPLY
---	YELLOW	PARKING BRAKES
---	BLUE	STANDARD SUSPENSION
---	BLACK	ACCESSORIES

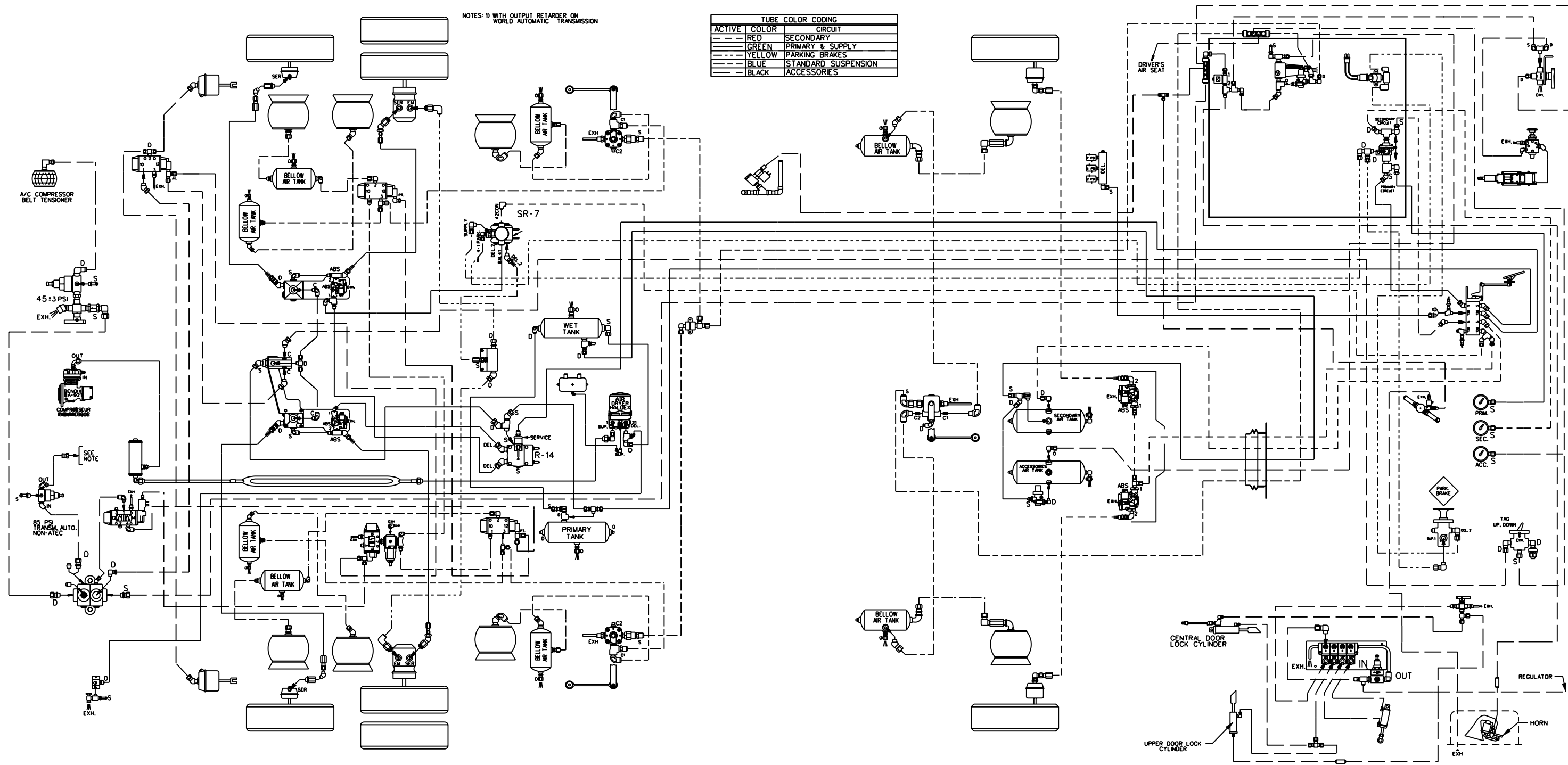

**PREVOST**

DESCRIPTION:  
X3-45 COACH, WITH INDEPENDENT FRONT SUSPENSION (I.F.S.)  
FULL PNEUMATIC SYSTEM

EFF. W/ VEH : #9-9504  
DATE: 2008/04 REV.: G

PAGE:  
D140330 P.1



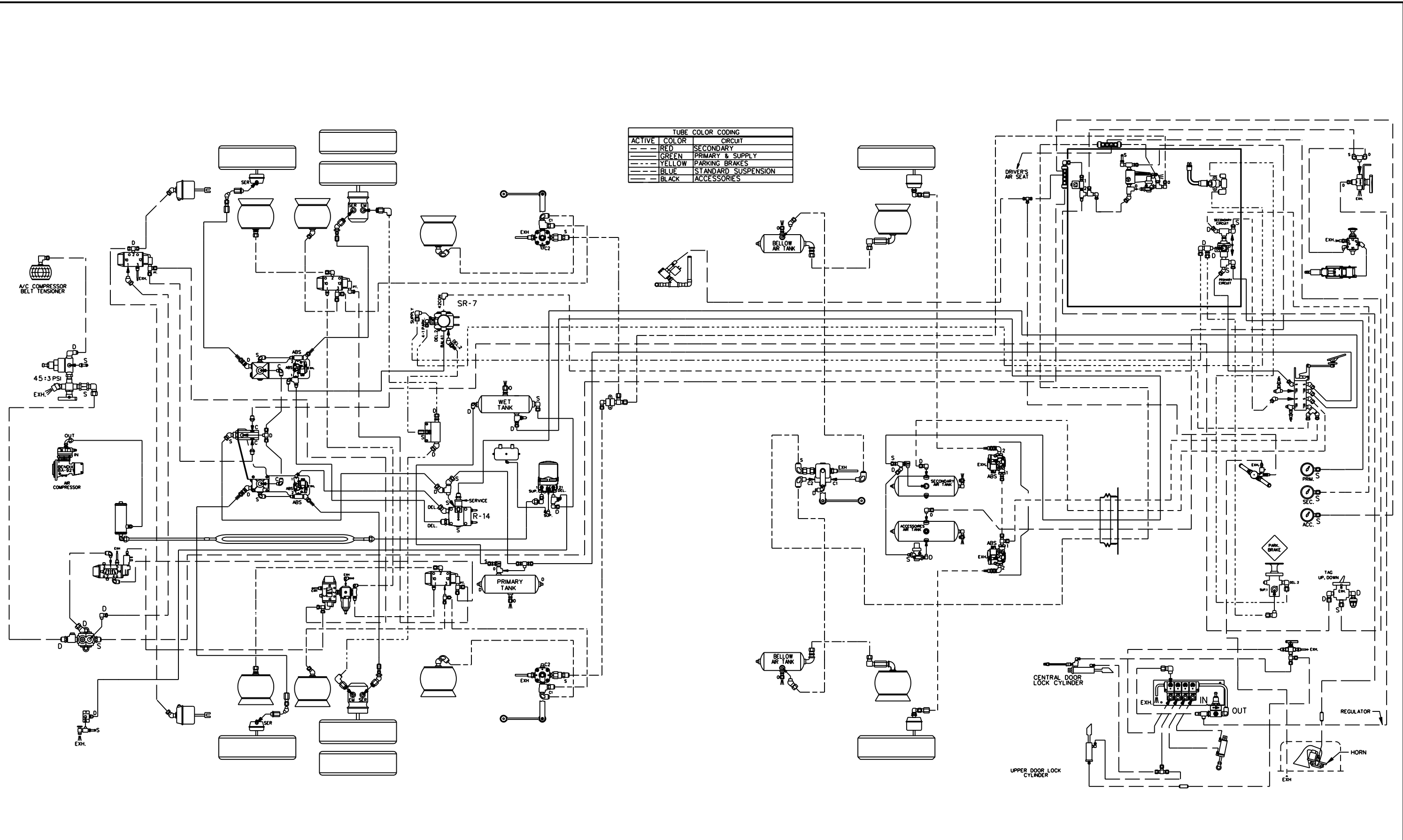

TUBE COLOR CODING		
ACTIVE	COLOR	CIRCUIT
---	RED	SECONDARY
---	GREEN	PRIMARY & SUPPLY
---	YELLOW	PARKING BRAKES
---	BLUE	STANDARD SUSPENSION
---	BLACK	ACCESSORIES

**PREVOST.**

DESCRIPTION:  
 X3-45 COACH, WITH INDEPENDENT FRONT SUSPENSION (I.F.S.)  
 FULL PNEUMATIC SYSTEM

EFF. W/ VEH : #9-9599...  
 DATE: 2008/07 REV.: H

PAGE:  
 D140330 P.1

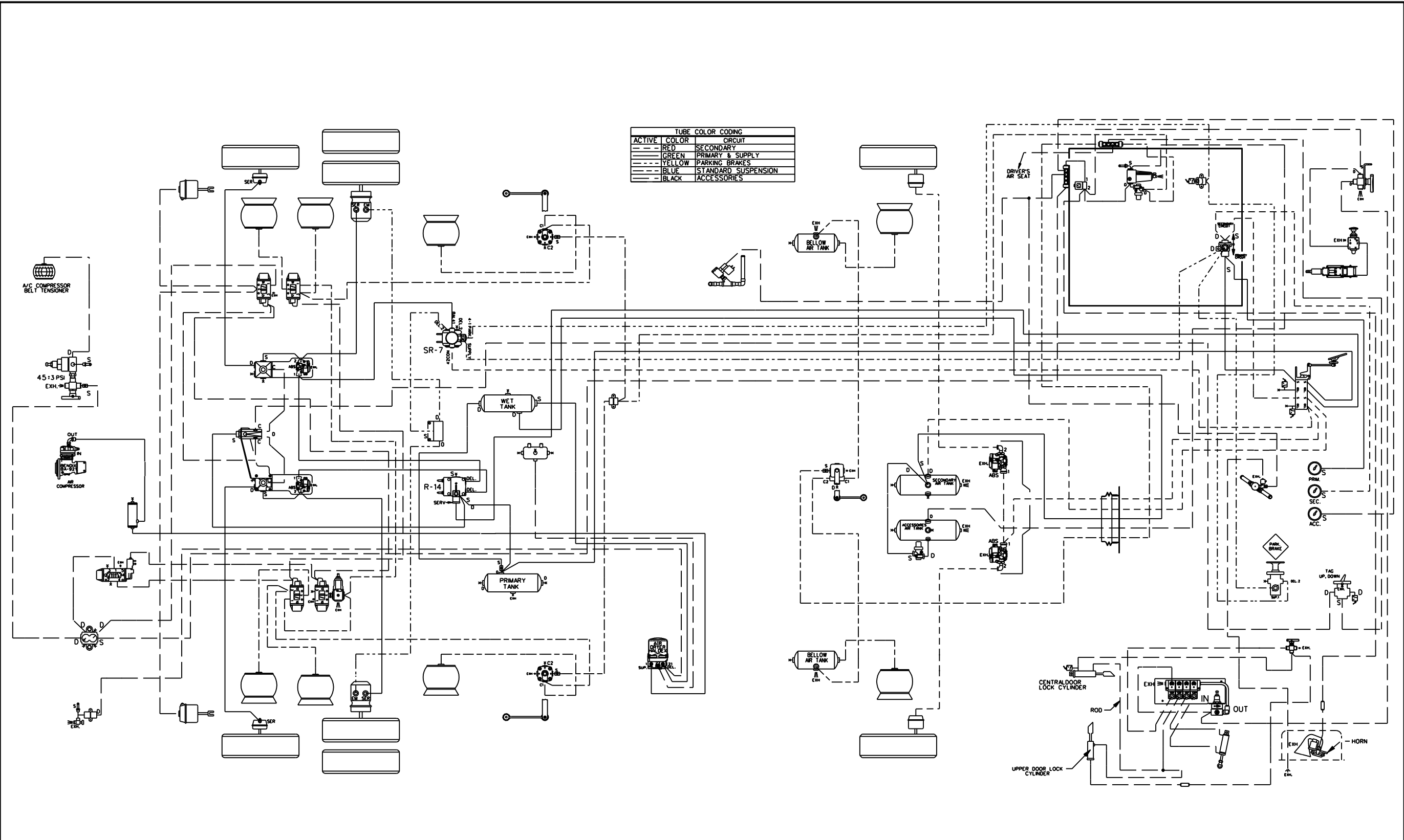

**PREVOST**

DESCRIPTION:  
 X3-45 COACH, WITH INDEPENDENT FRONT SUSPENSION (I.F.S.)  
 FULL PNEUMATIC SYSTEM

EFF. W/ VEH : #A-9953  
 DATE: 2010/04  
 REV.: i

PAGE:  
 D140330 P.1

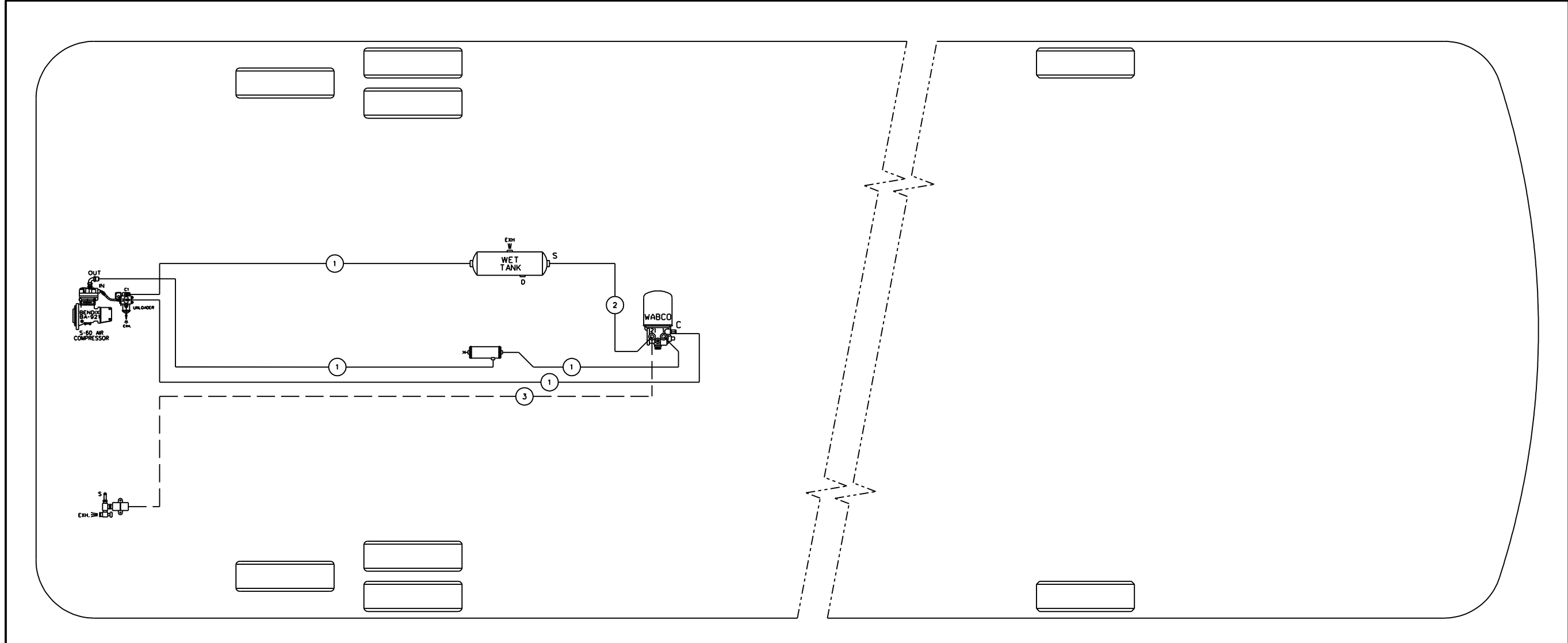

TUBE COLOR CODING		
ACTIVE	COLOR	CIRCUIT
—	GREEN	PRIMARY & SUPPLY
—	BLACK	ACCESSORIES

BALLOON	PIPE
•1	HOSE ASS'Y
•2	3/4" O.D. GREEN
•3	1/4" O.D. BLACK

**PREVOST**®

DESCRIPTION:  
 X3-45 COACH, WITH INDEPENDENT FRONT SUSPENSION (I.F.S.)  
 WITH OPTION WABCO AIR DRYER INTO REAR SUB FRAME

EFF. W/ VEH : #A-9953...  
 DATE: 2010/05  
 REV.: D

PAGE:  
 D140330 SP1.1

NOTES: 1) WITH OUTPUT RETARDER ON WORLD AUTOMATIC TRANSMISSION

TUBE COLOR CODING		
ACTIVE	COLOR	CIRCUIT
—	BLACK	ACCESSORIES

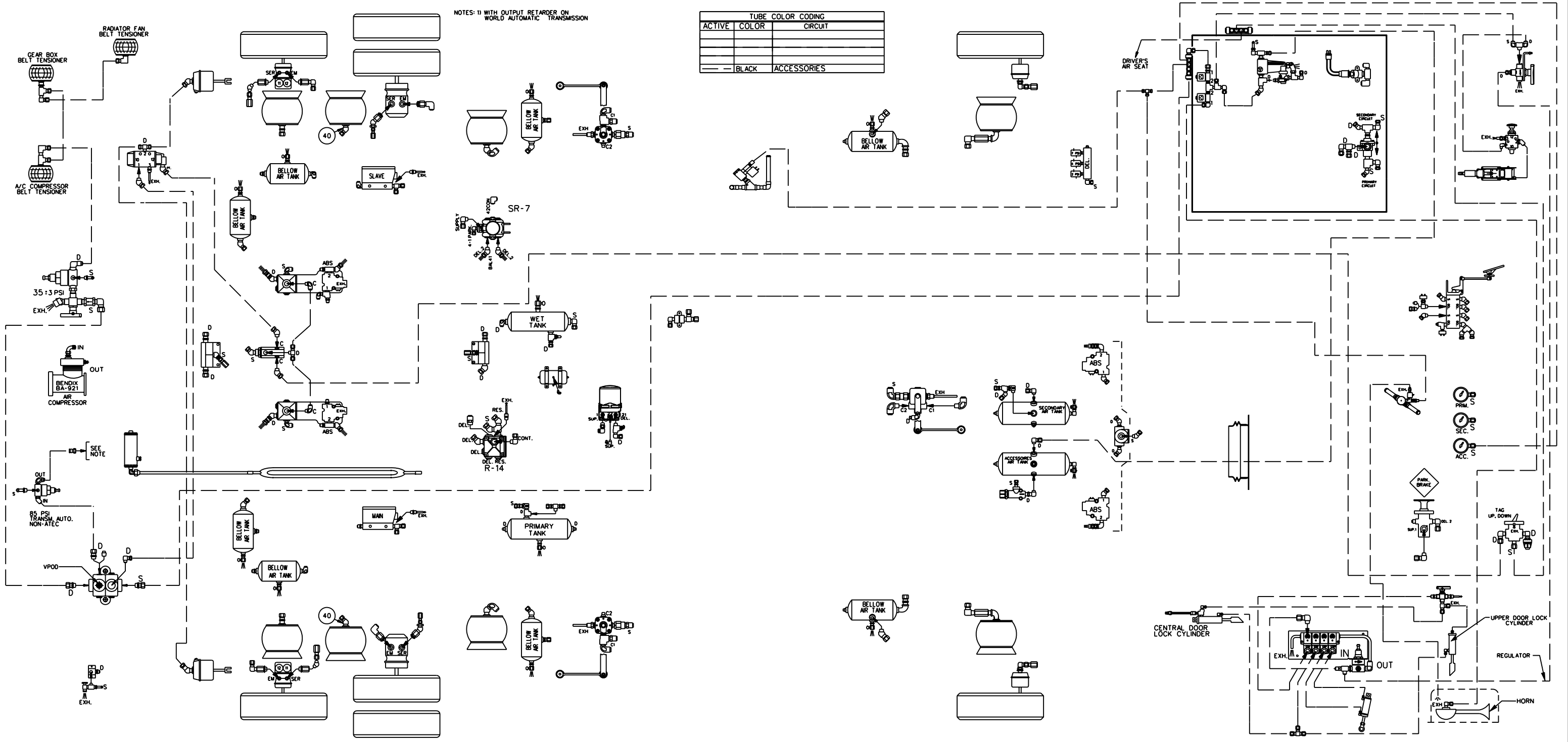

**PREVOST**

DESCRIPTION:  
X3-45 COACH, WITH INDEPENDENT FRONT SUSPENSION (I.F.S.)  
ACCESSORIES

EFF. W/ VEH : #7-8933...  
DATE: 2006/03  
REV.: A

PAGE:  
D140330P1.2

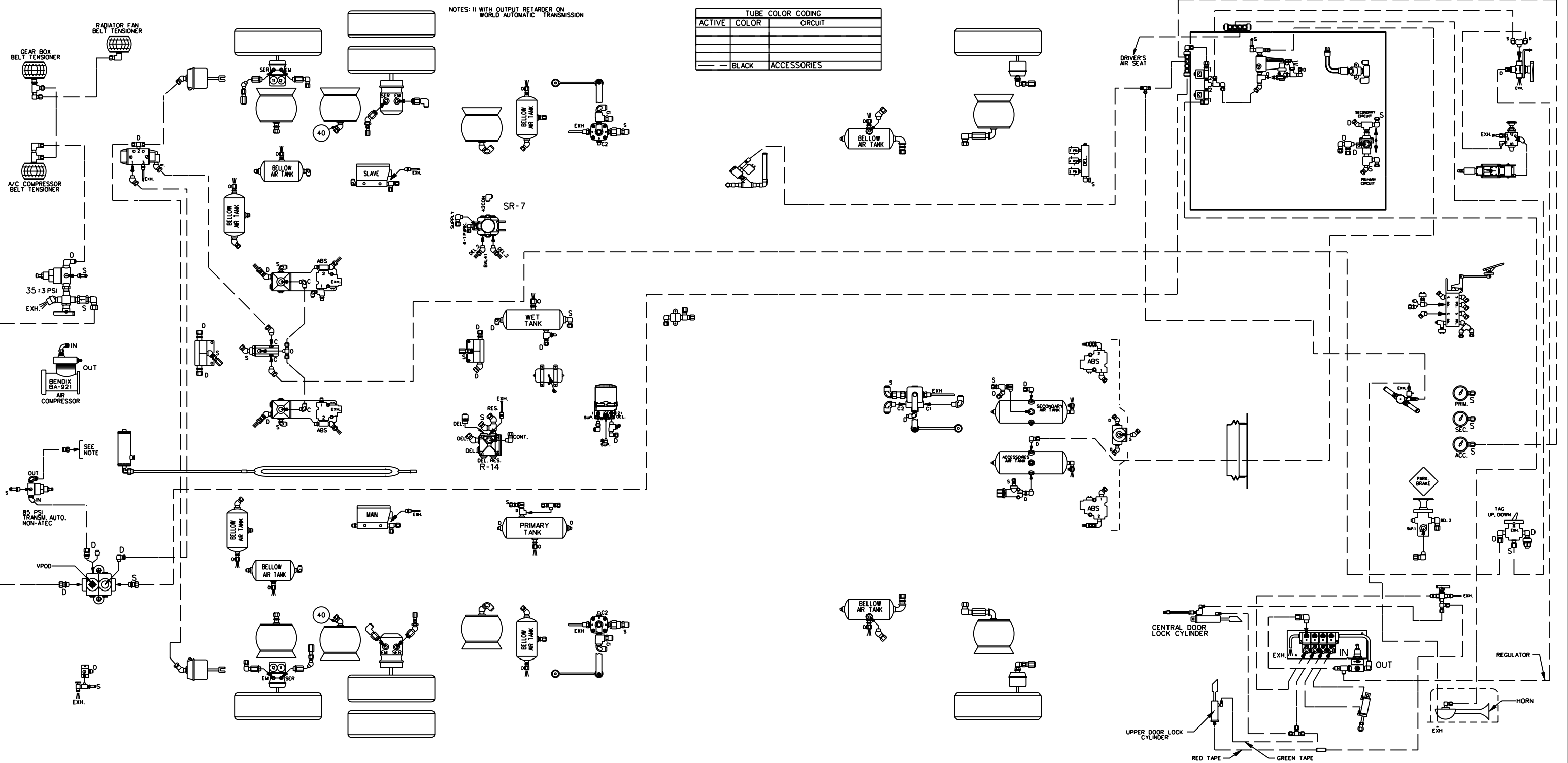

**PREVOST**®

DESCRIPTION:

X3-45 COACH, WITH INDEPENDENT FRONT SUSPENSION (I.F.S.)  
ACCESSORIES

EFF. W/ VEH :

#7-9035...

PAGE:

D140330P1.2

DATE:

2006/08

REV.:

B

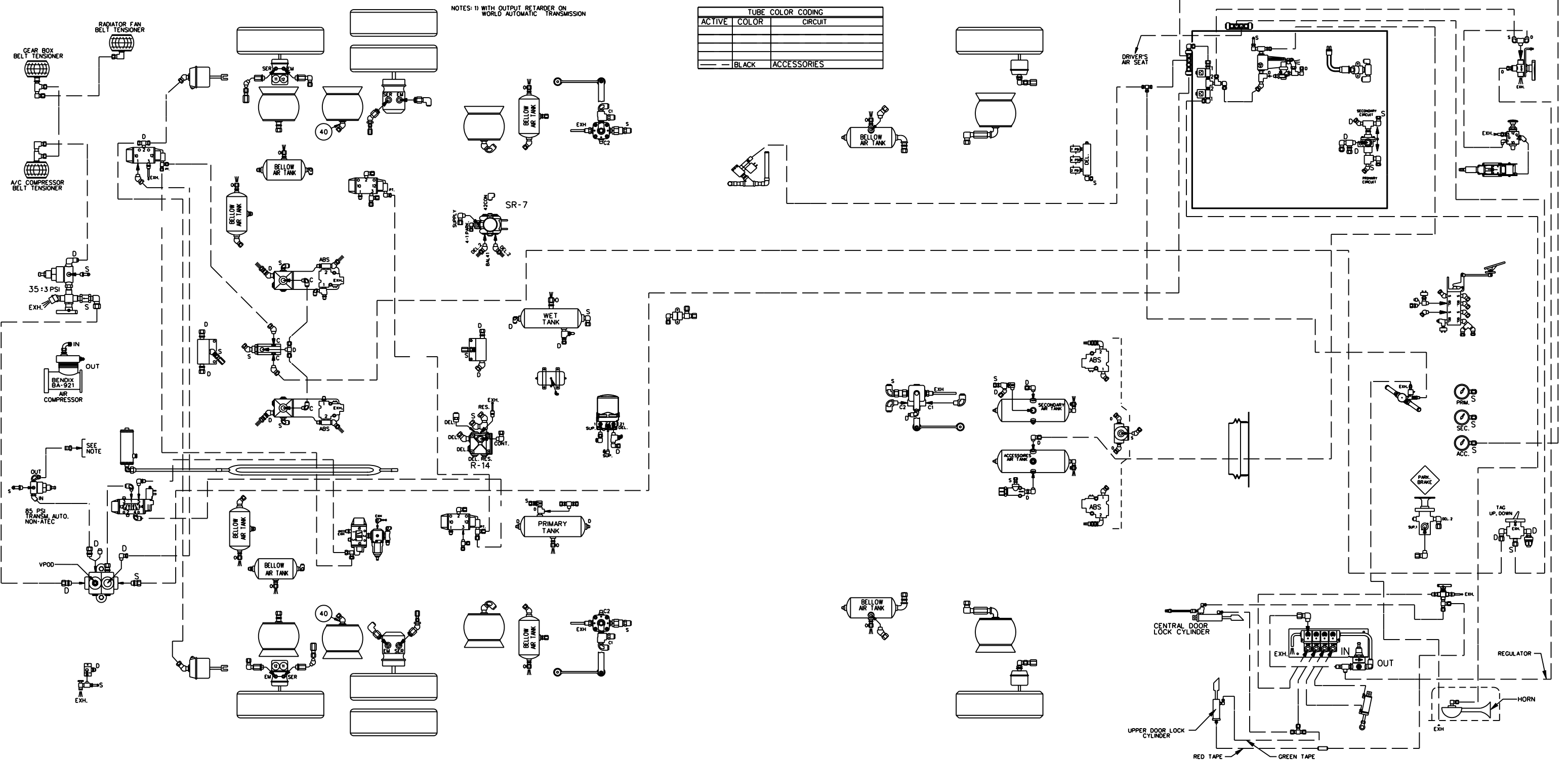

**PREVOST®**

DESCRIPTION:

X3-45 COACH, WITH INDEPENDENT FRONT SUSPENSION (I.F.S.)  
ACCESSORIES

EFF. W/ VEH :

#8-9226...

PAGE:

D140330P1.2

DATE:

2007/04

REV.:

C

NOTES: 1) WITH OUTPUT RETARDER ON  
WORLD AUTOMATIC TRANSMISSION

TUBE COLOR CODING		
ACTIVE	COLOR	CIRCUIT
---	BLACK	ACCESSORIES

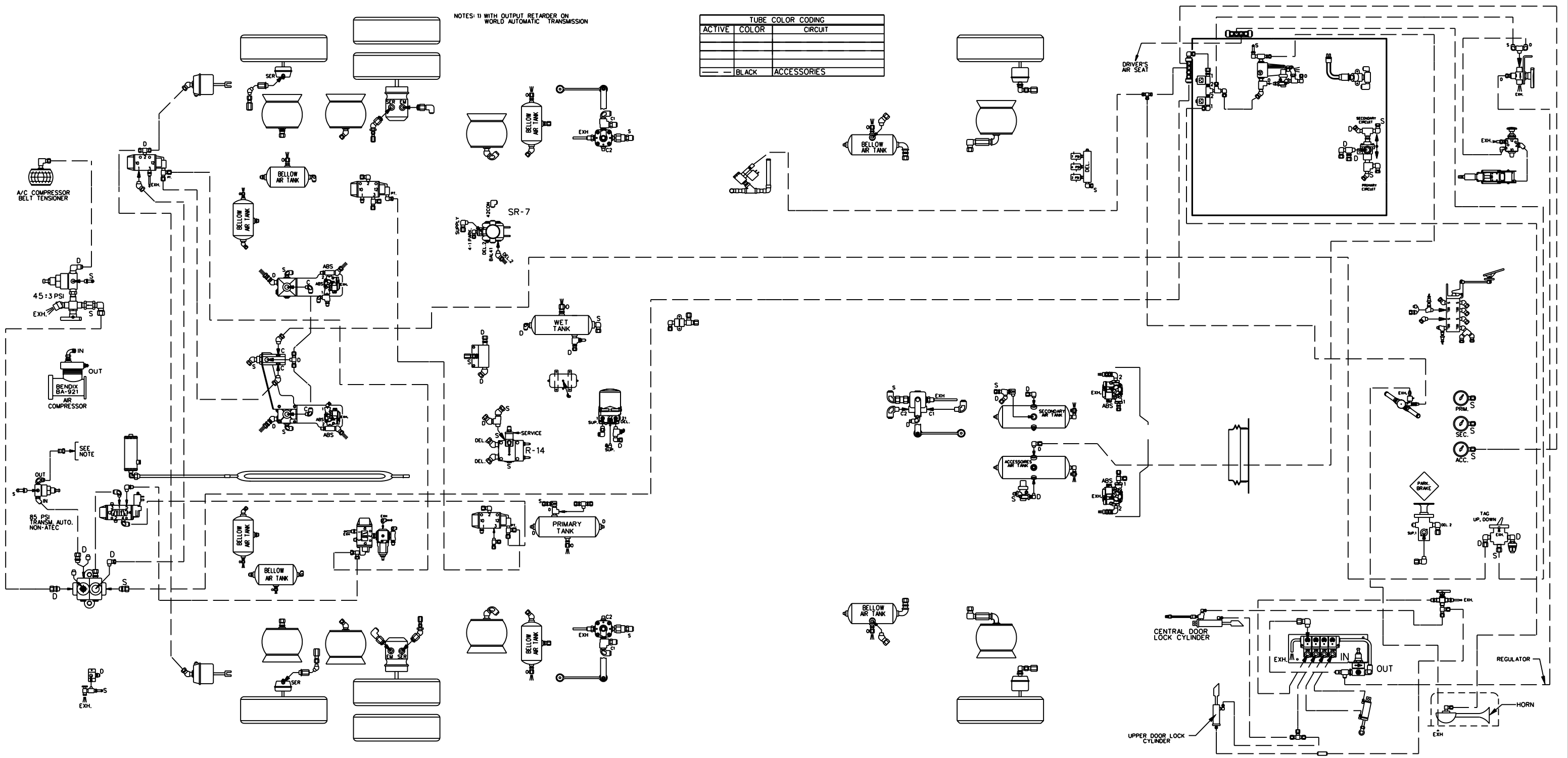

**PREVOST**

DESCRIPTION:  
X3-45 COACH, WITH INDEPENDENT FRONT SUSPENSION (I.F.S.)  
ACCESSORIES

EFF. W/ VEH : #8-9295...  
DATE: 2007/07 REV.: D

PAGE:  
D140330P1.2

NOTES: 1) WITH OUTPUT RETARDER ON WORLD AUTOMATIC TRANSMISSION

TUBE COLOR CODING		
ACTIVE	COLOR	CIRCUIT
---	BLACK	ACCESSORIES

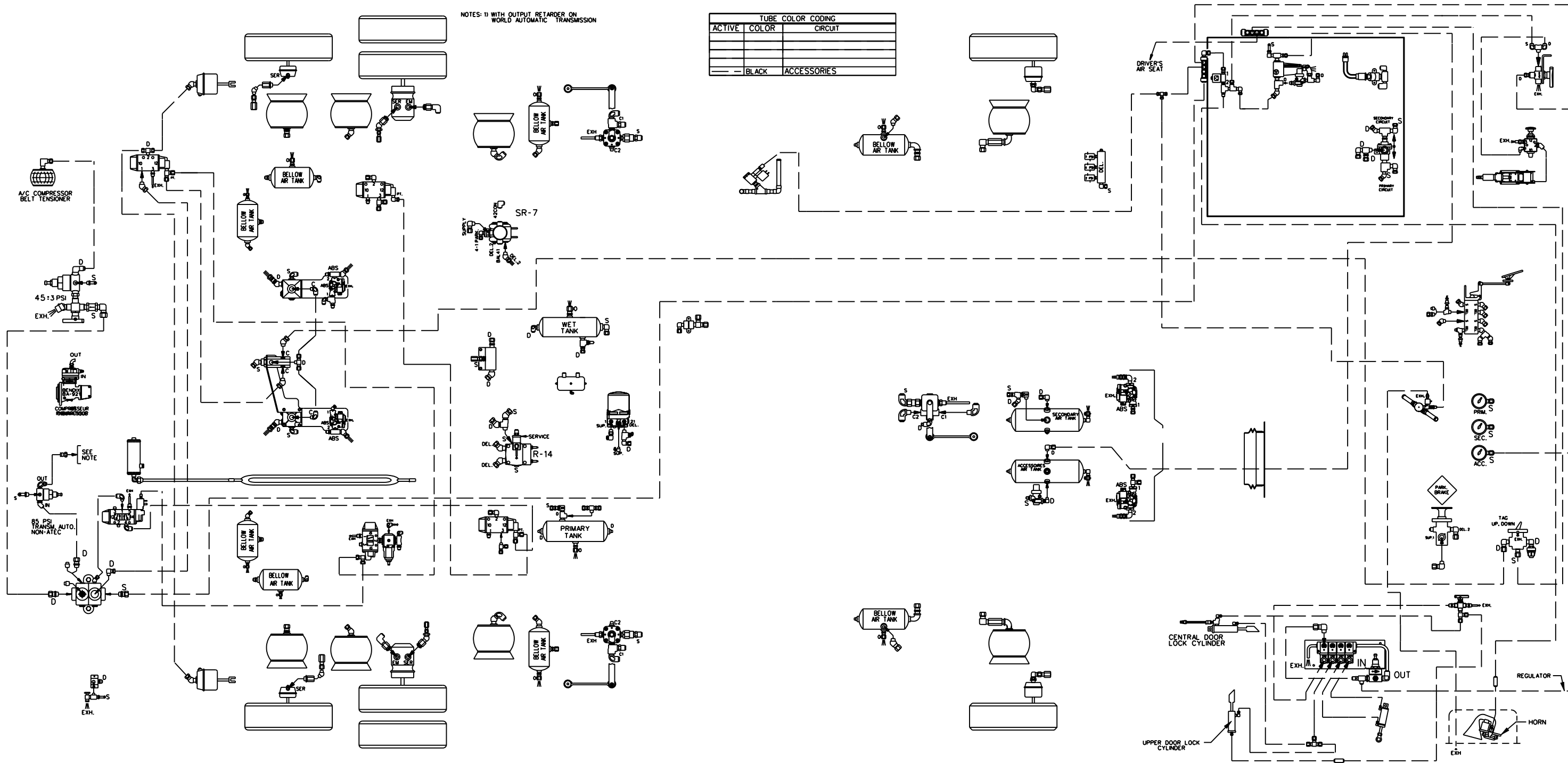

**PREVOST**®

DESCRIPTION:  
X3-45 COACH, WITH INDEPENDENT FRONT SUSPENSION (I.F.S.)  
ACCESSORIES

EFF. W/ VEH : #8-9422...  
DATE: 2008/03 REV.: F

PAGE:  
D140330P1.2



NOTES: 1) WITH OUTPUT RETARDER ON WORLD AUTOMATIC TRANSMISSION

TUBE COLOR CODING		
ACTIVE	COLOR	CIRCUIT
—	BLACK	ACCESSORIES

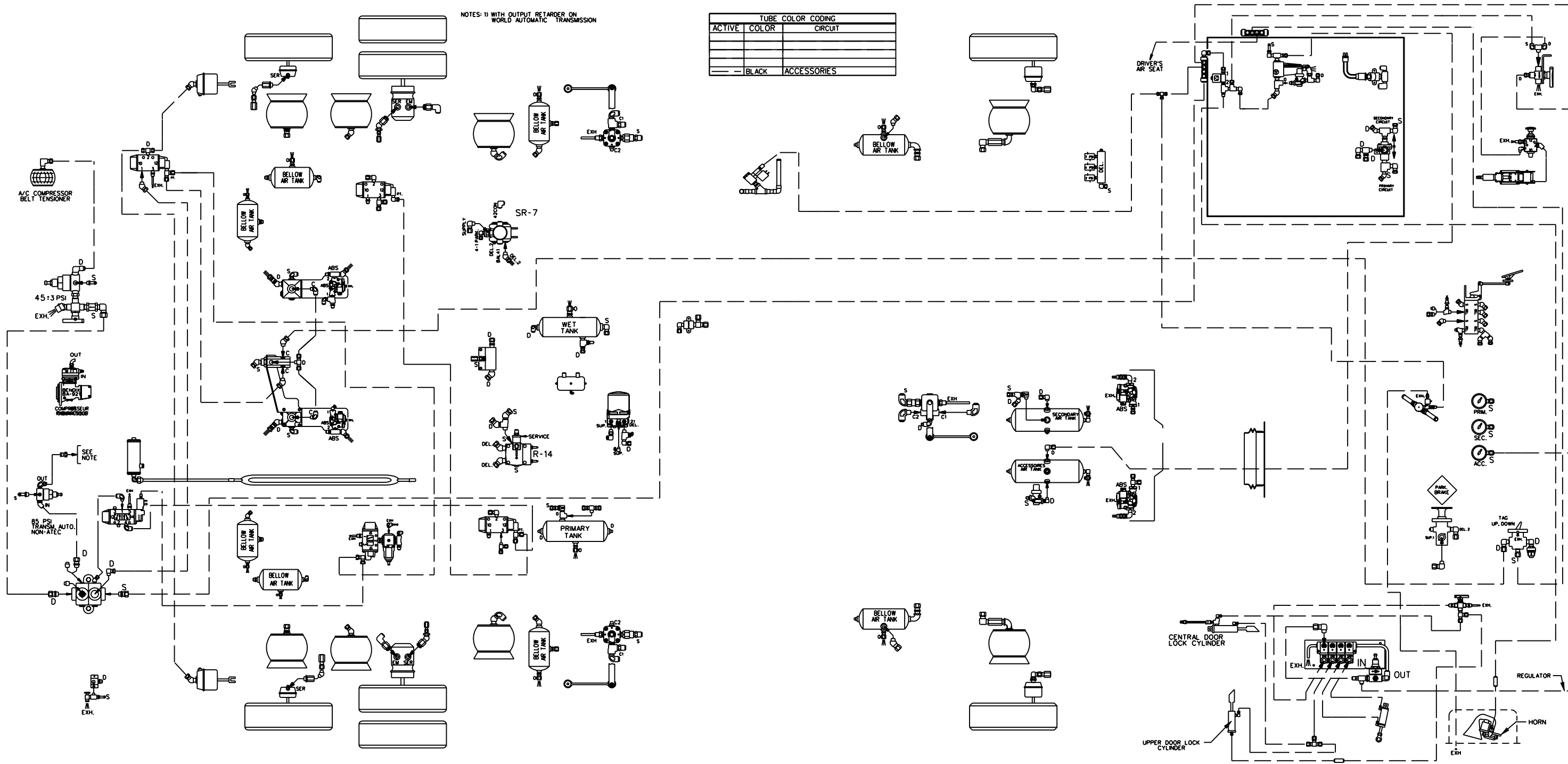

**PREVOST**

DESCRIPTION:  
X3-45 COACH, WITH INDEPENDENT FRONT SUSPENSION (I.F.S.)  
ACCESSORIES

EFF. W/ VEH : #9-9504  
DATE: 2008/04 REV.: G

PAGE:  
D140330 P1.2

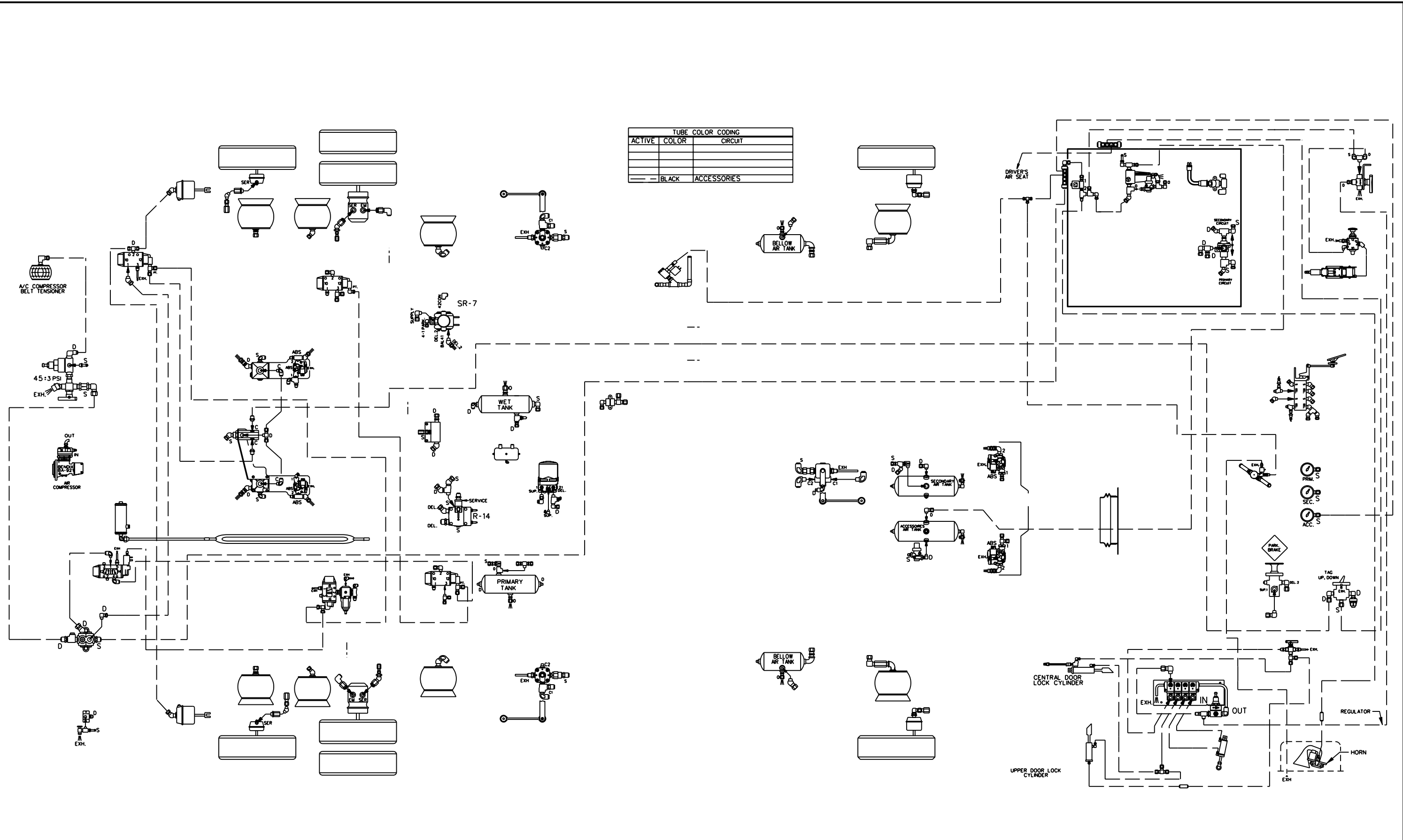

**PREVOST**®

DESCRIPTION:  
X3-45 COACH, WITH INDEPENDENT FRONT SUSPENSION (I.F.S.)  
ACCESSORIES

EFF. W/ VEH : #9-9599...  
DATE: 2008/07 REV.: H

PAGE:  
D140330 P1.2

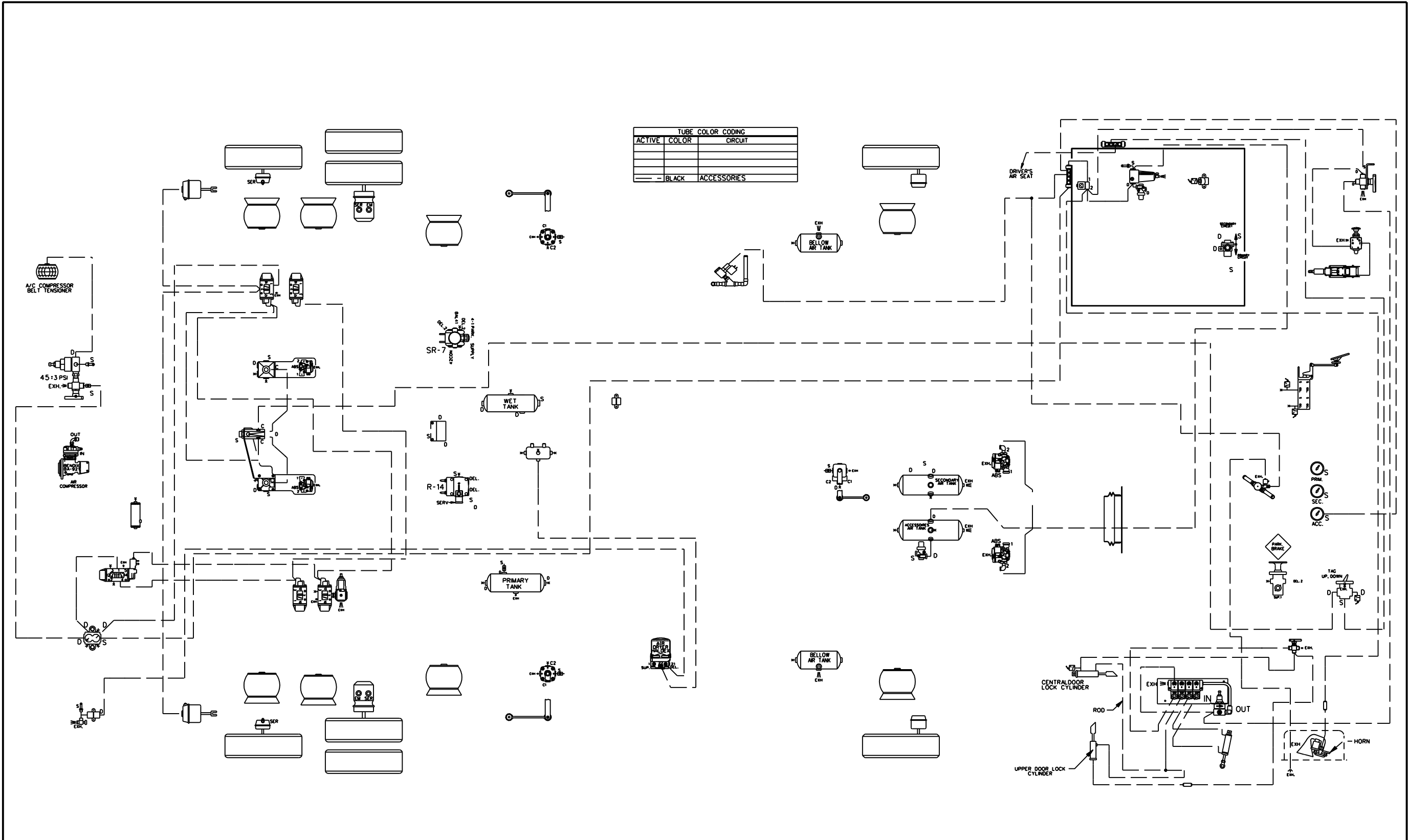

**PREVOST**

DESCRIPTION:  
X3-45 COACH, WITH INDEPENDENT FRONT SUSPENSION (I.F.S.)  
ACCESSORIES

EFF. W/ VEH : #A-9953  
DATE: 2010/04 REV.: i

PAGE:  
D140330 P1.2

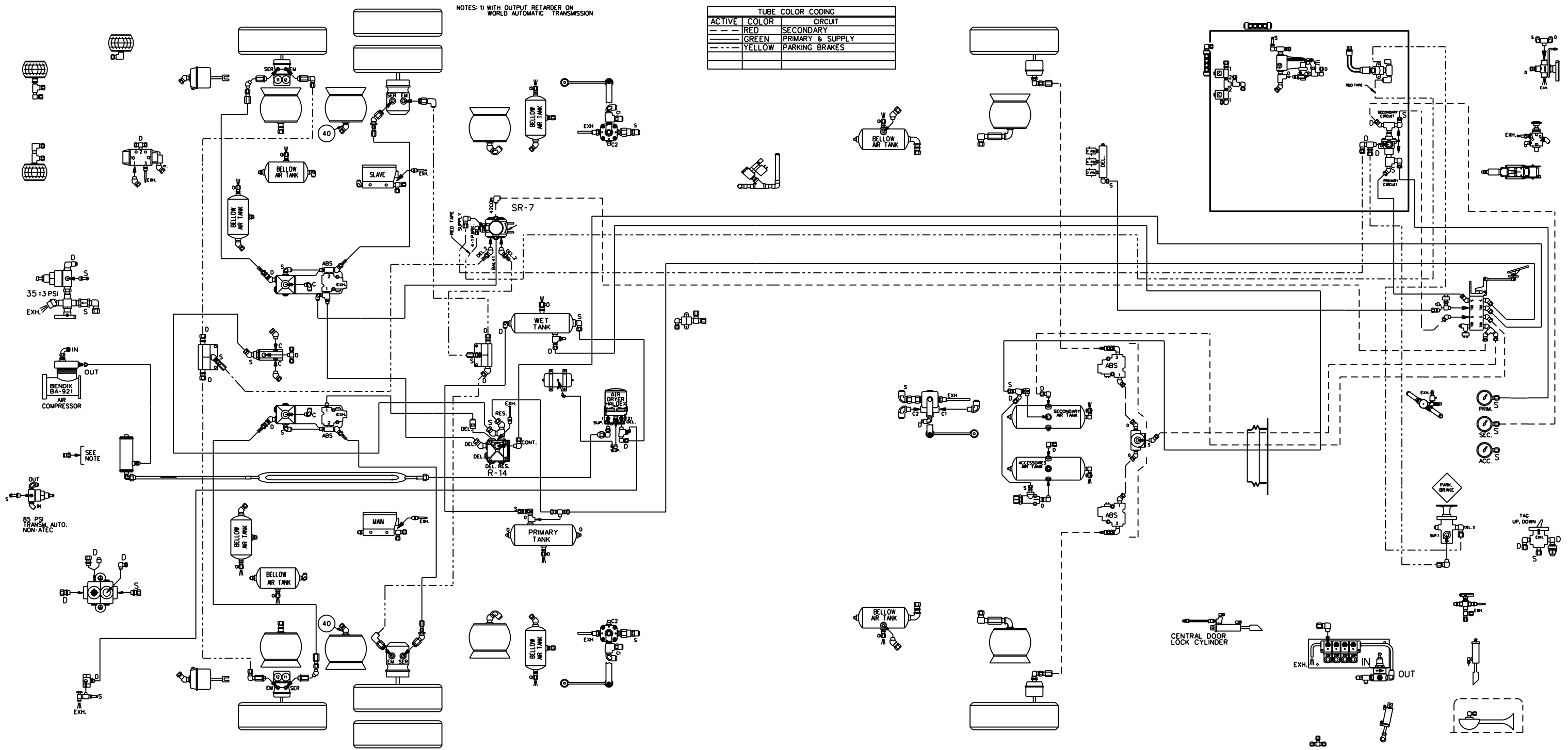

**PREVOST**

DESCRIPTION:

X3-45 COACH, WITH INDEPENDENT FRONT SUSPENSION (I.F.S.)  
BRAKES SYSTEM

EFF. W/ VEH : #7-8933...

PAGE:

DATE: 2006/03

REV.: A

D140330 P1.3

NOTES: 1) WITH OUTPUT RETARDER ON  
WORLD AUTOMATIC TRANSMISSION

ACTIVE	COLOR	CIRCUIT
---	RED	SECONDARY
---	GREEN	PRIMARY & SUPPLY
---	YELLOW	PARKING BRAKES

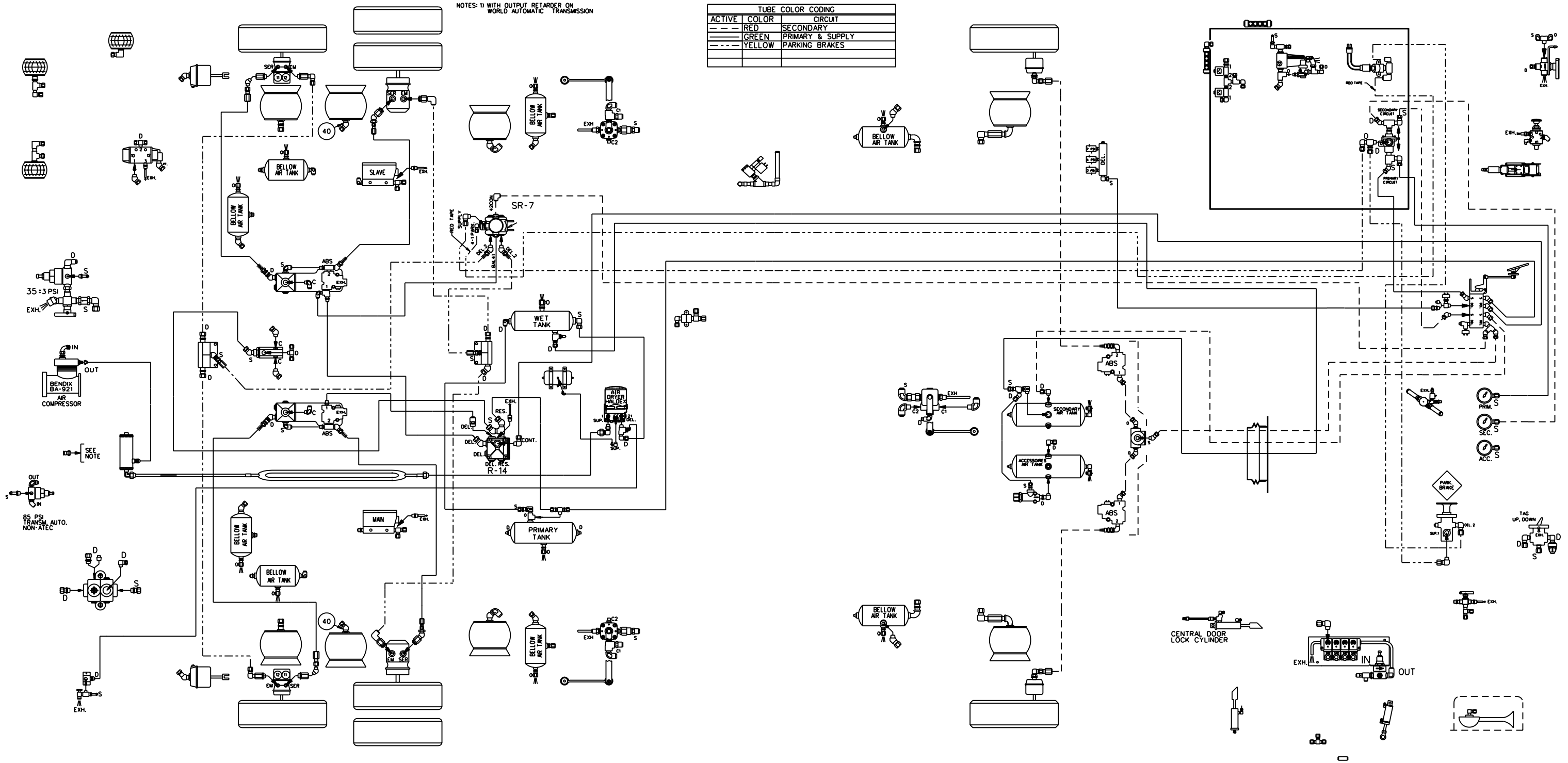

**PREVOST**

DESCRIPTION:  
X3-45 COACH, WITH INDEPENDENT FRONT SUSPENSION (I.F.S.)  
BRAKES SYSTEM

EFF. W/ VEH : #7-9035...  
DATE: 2006/08 REV.: B

PAGE:  
D140330 P1.3

NOTES: 1) WITH OUTPUT RETARDER ON  
WORLD AUTOMATIC TRANSMISSION

TUBE COLOR CODING		
ACTIVE	COLOR	CIRCUIT
---	RED	SECONDARY
---	GREEN	PRIMARY & SUPPLY
---	YELLOW	PARKING BRAKES

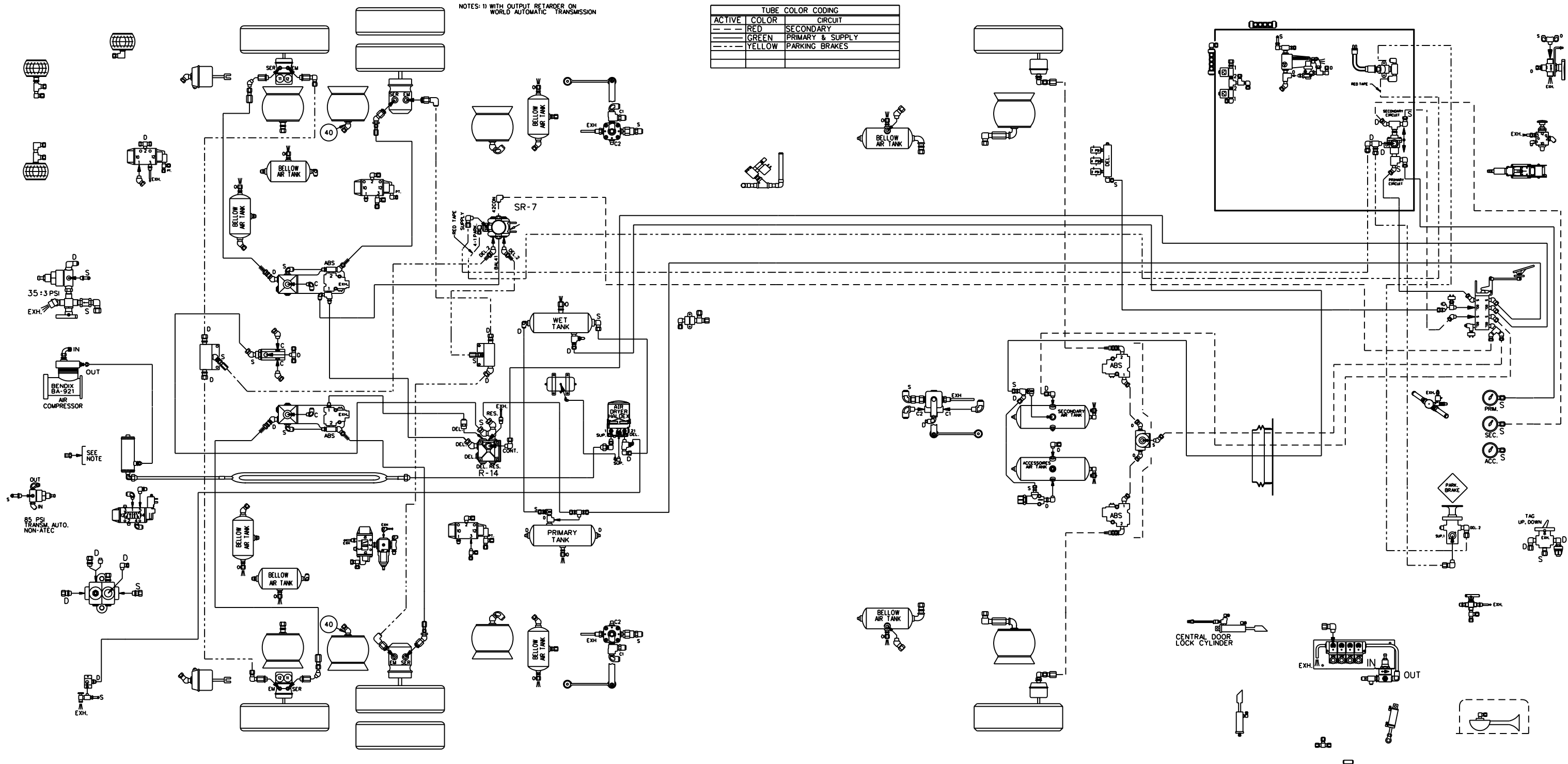

**PREVOST**®

DESCRIPTION:  
X3-45 COACH, WITH INDEPENDENT FRONT SUSPENSION (I.F.S.)  
BRAKES SYSTEM

EFF. W/ VEH : #8-9226...  
DATE: 2007/04 REV.: C

PAGE:  
D140330 P1.3

NOTES: 1) WITH OUTPUT RETARDER ON  
WORLD AUTOMATIC TRANSMISSION

ACTIVE	COLOR	CIRCUIT
---	RED	SECONDARY
---	GREEN	PRIMARY & SUPPLY
---	YELLOW	PARKING BRAKES

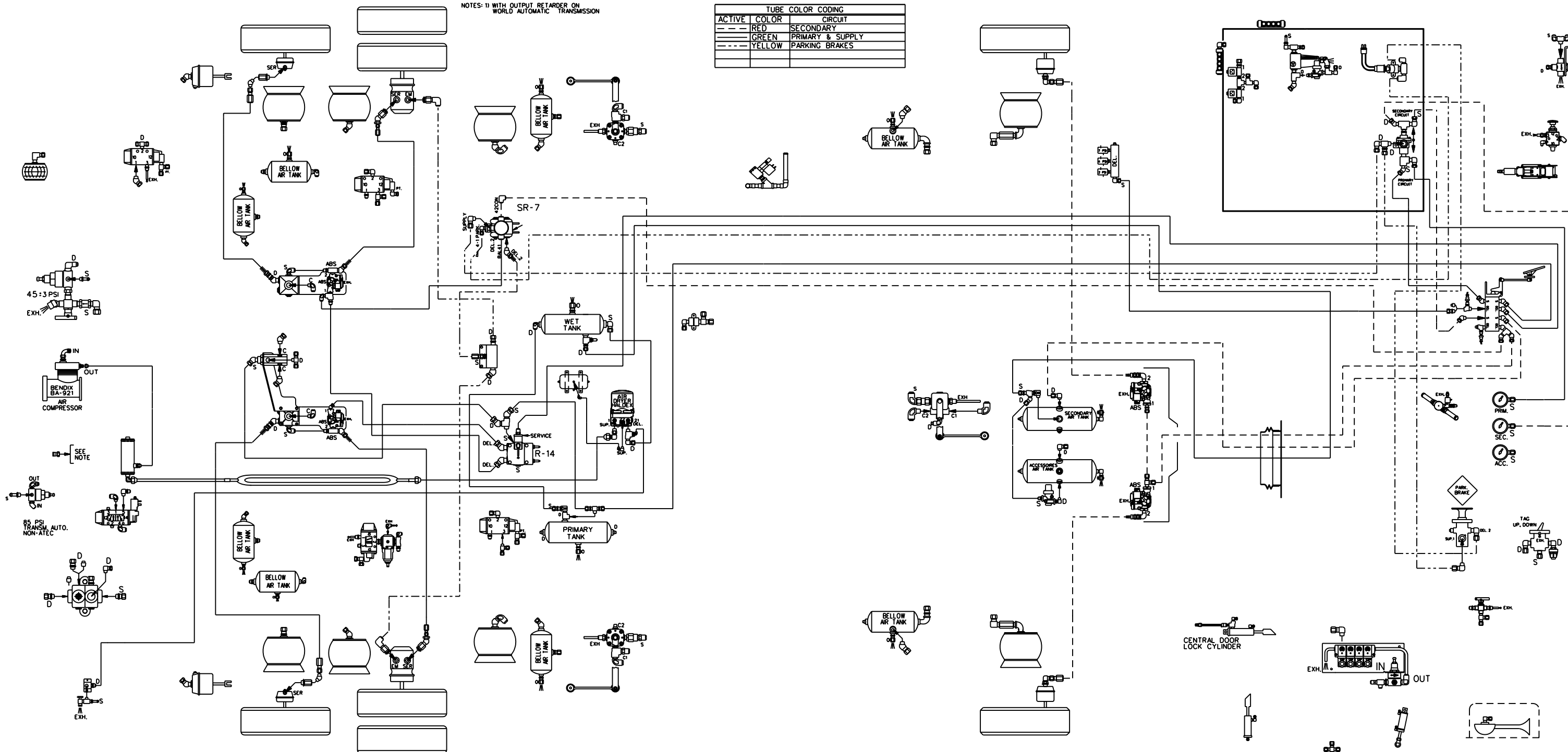

**PREVOST®**

DESCRIPTION:  
X3-45 COACH, WITH INDEPENDENT FRONT SUSPENSION (I.F.S.)  
BRAKES SYSTEM

EFF. W/ VEH : #8-9295...  
DATE: 2007/07 REV.: D

PAGE:  
D140330 P1.3

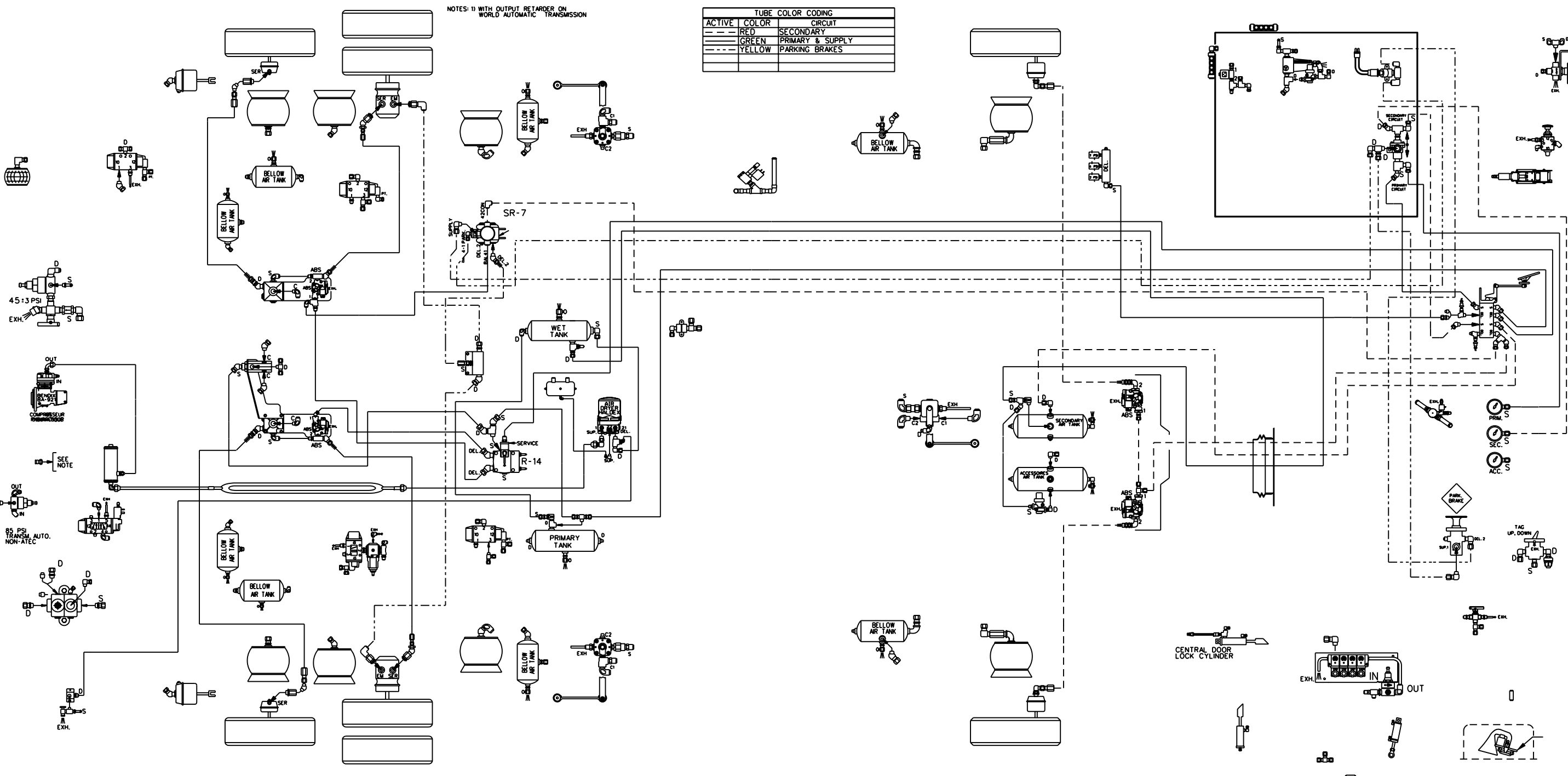

**PREVOST.**

DESCRIPTION:  
X3-45 COACH, WITH INDEPENDENT FRONT SUSPENSION (I.F.S.)  
BRAKES SYSTEM

EFF. W/ VEH : #8-9422...  
DATE: 2008/03 REV.: F

PAGE:  
D140330 P1.3



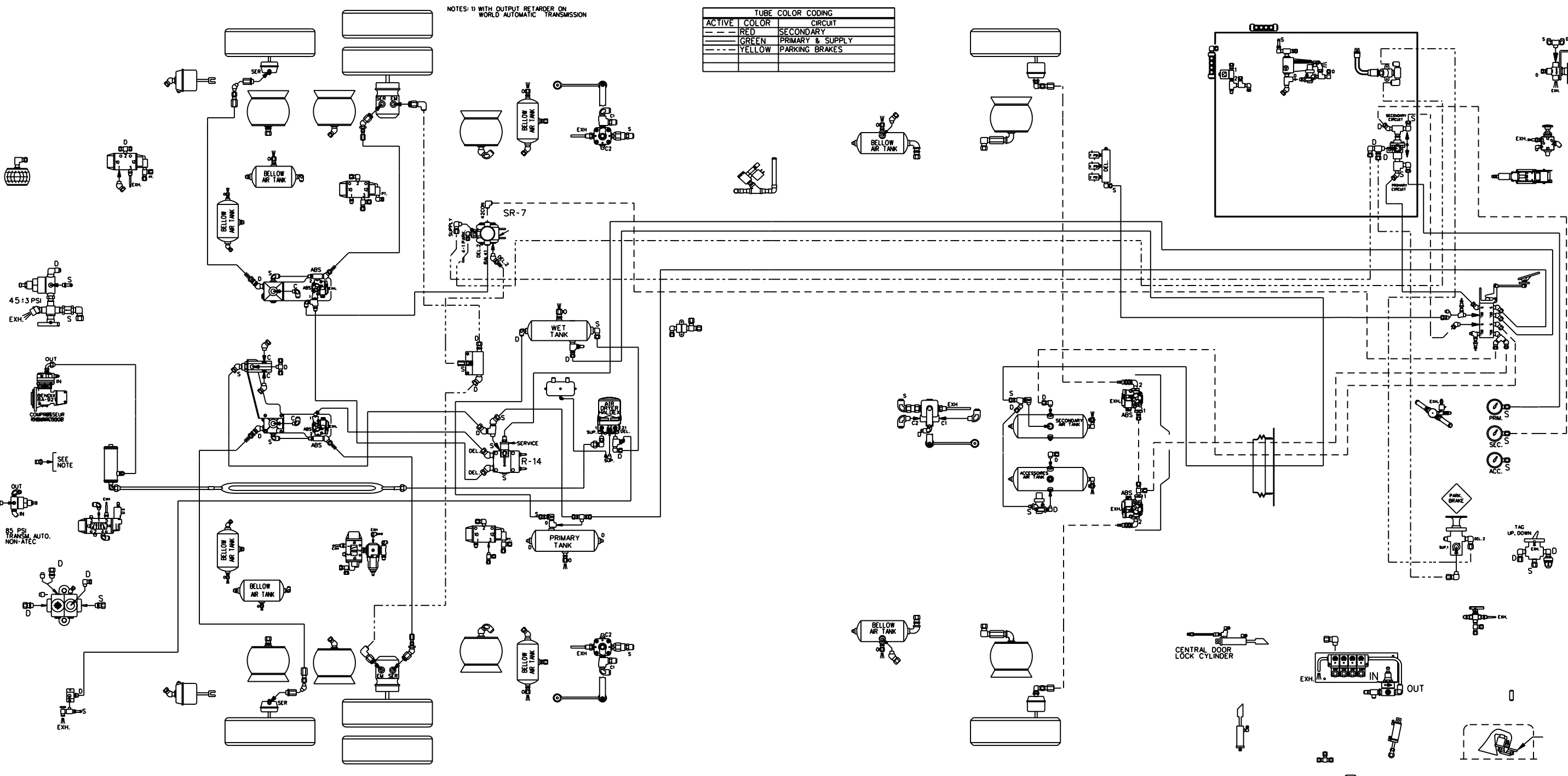

**PREVOST.**

DESCRIPTION:  
X3-45 COACH, WITH INDEPENDENT FRONT SUSPENSION (I.F.S.)  
BRAKES SYSTEM

EFF. W/ VEH : #9-9504  
DATE: 2008/04 REV.: G

PAGE:  
D140330 P1.3

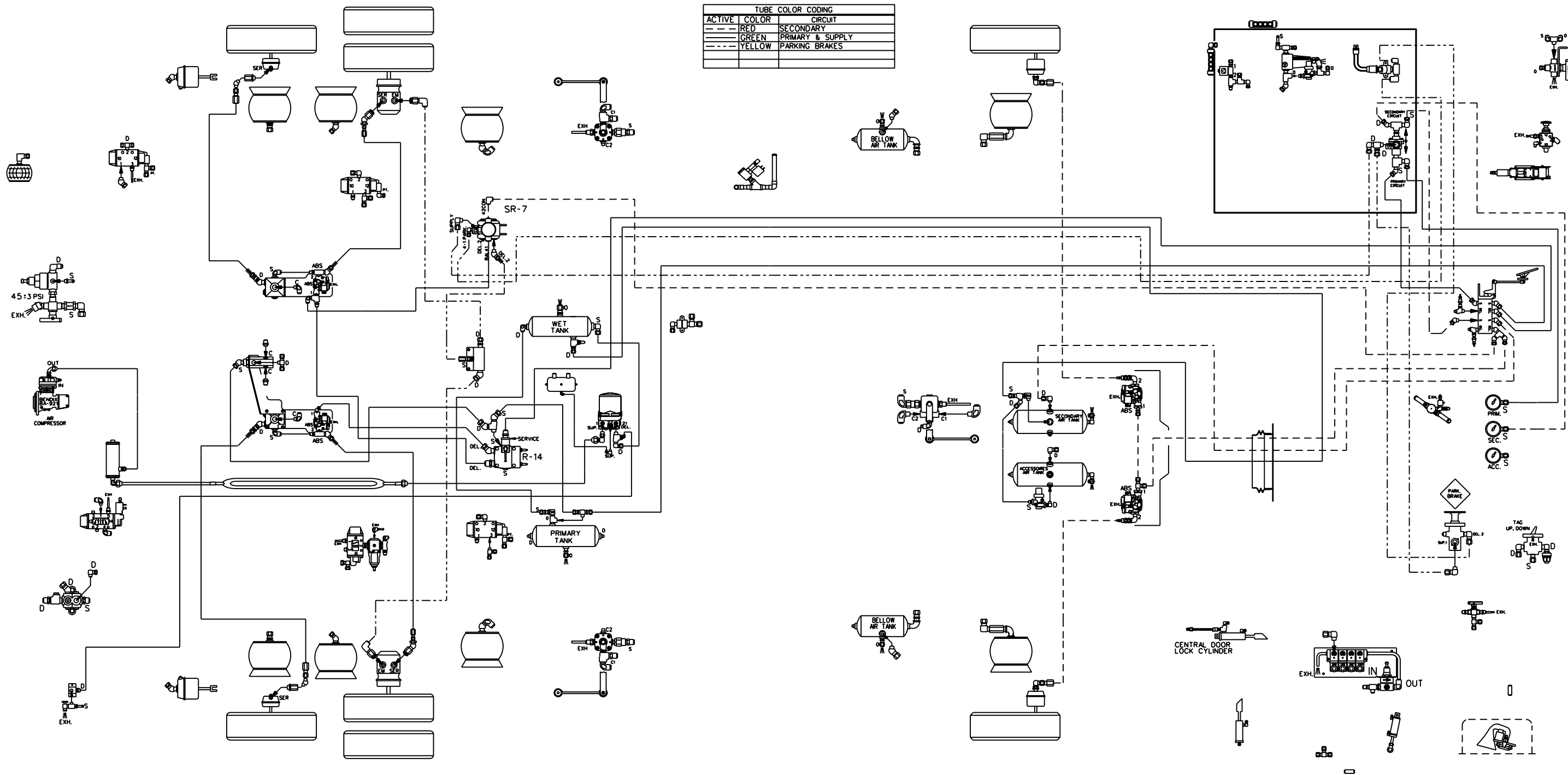

**PREVOST®**

DESCRIPTION:  
X3-45 COACH, WITH INDEPENDENT FRONT SUSPENSION (I.F.S.)  
BRAKES SYSTEM

EFF. W/ VEH : #9-9599...  
DATE: 2008/07 REV.: H

PAGE:  
D140330 P1.3

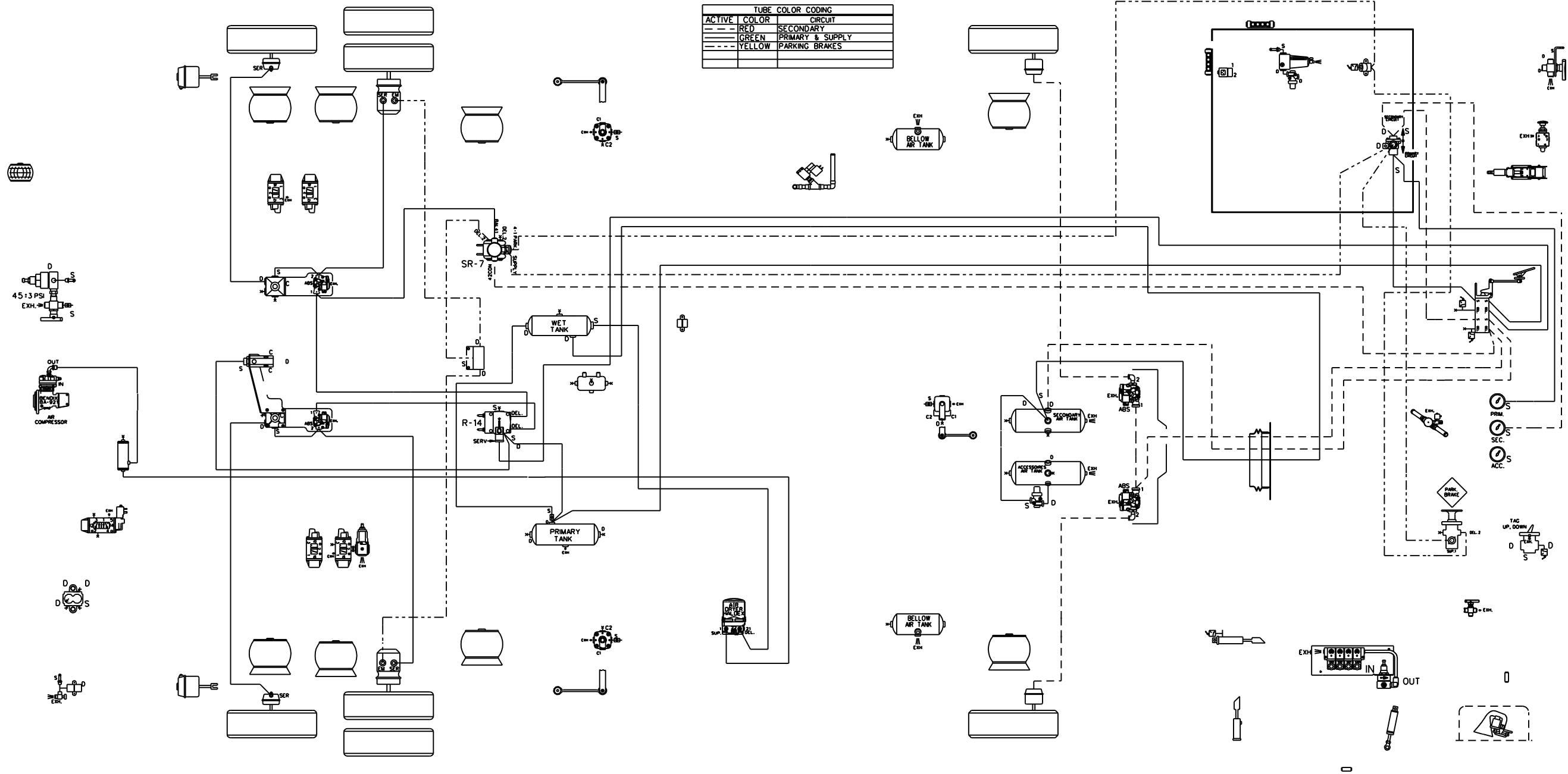

**PREVOST®**

DESCRIPTION:  
X3-45 COACH, WITH INDEPENDENT FRONT SUSPENSION (I.F.S.)  
BRAKES SYSTEM

EFF. W/ VEH : #A-9953

PAGE:

DATE: 2010/04

REV.: i

D140330 P1.3

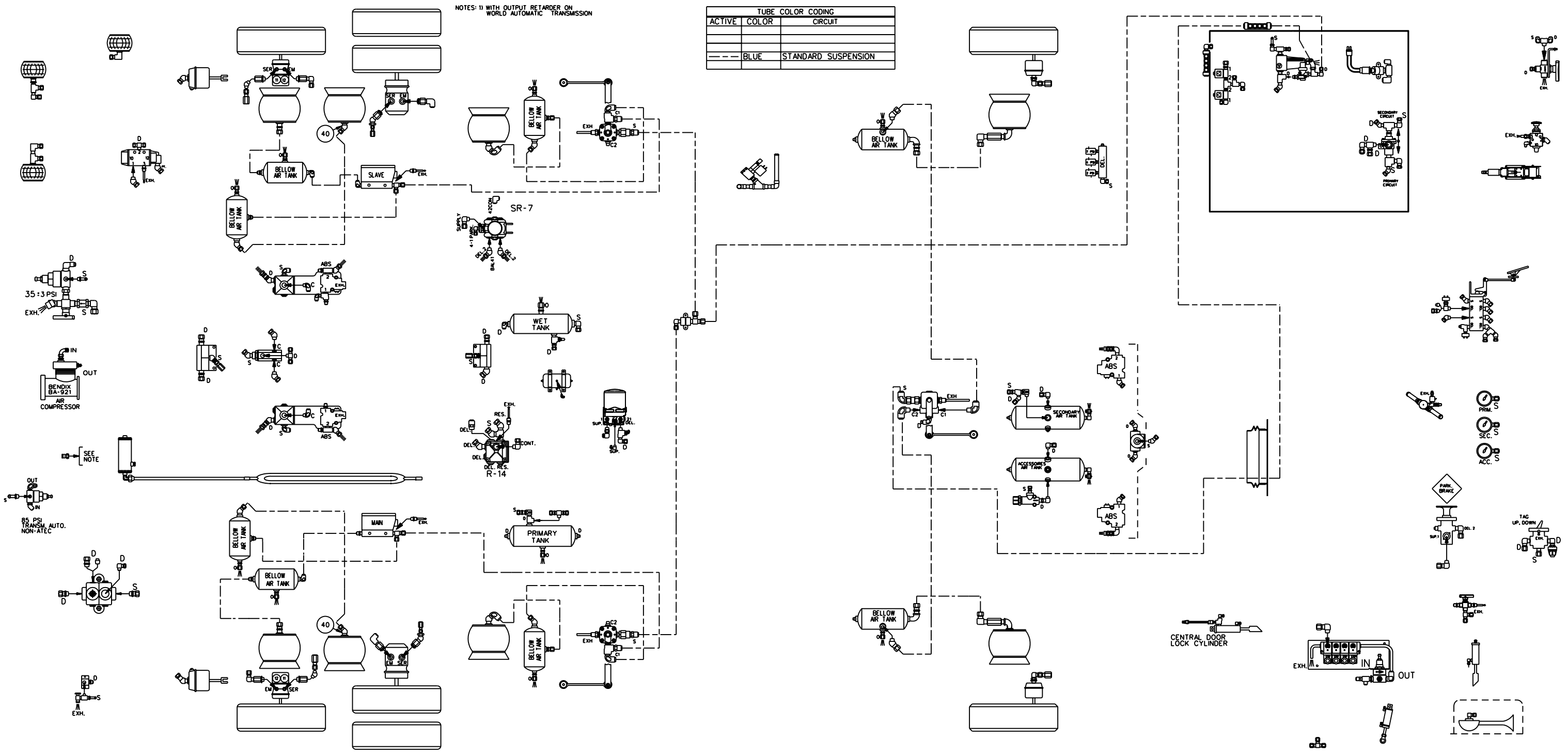

**PREVOST**

DESCRIPTION:  
X3-45 COACH, WITH INDEPENDENT FRONT SUSPENSION (I.F.S.)  
STANDARD SUSPENSION

EFF. W/ VEH : #7-8933...  
DATE: 2006/03  
REV.: A

PAGE:  
D140330 P1.4

NOTES: 1) WITH OUTPUT RETARDER ON  
WORLD AUTOMATIC TRANSMISSION

TUBE COLOR CODING		
ACTIVE	COLOR	CIRCUIT
---	BLUE	STANDARD SUSPENSION

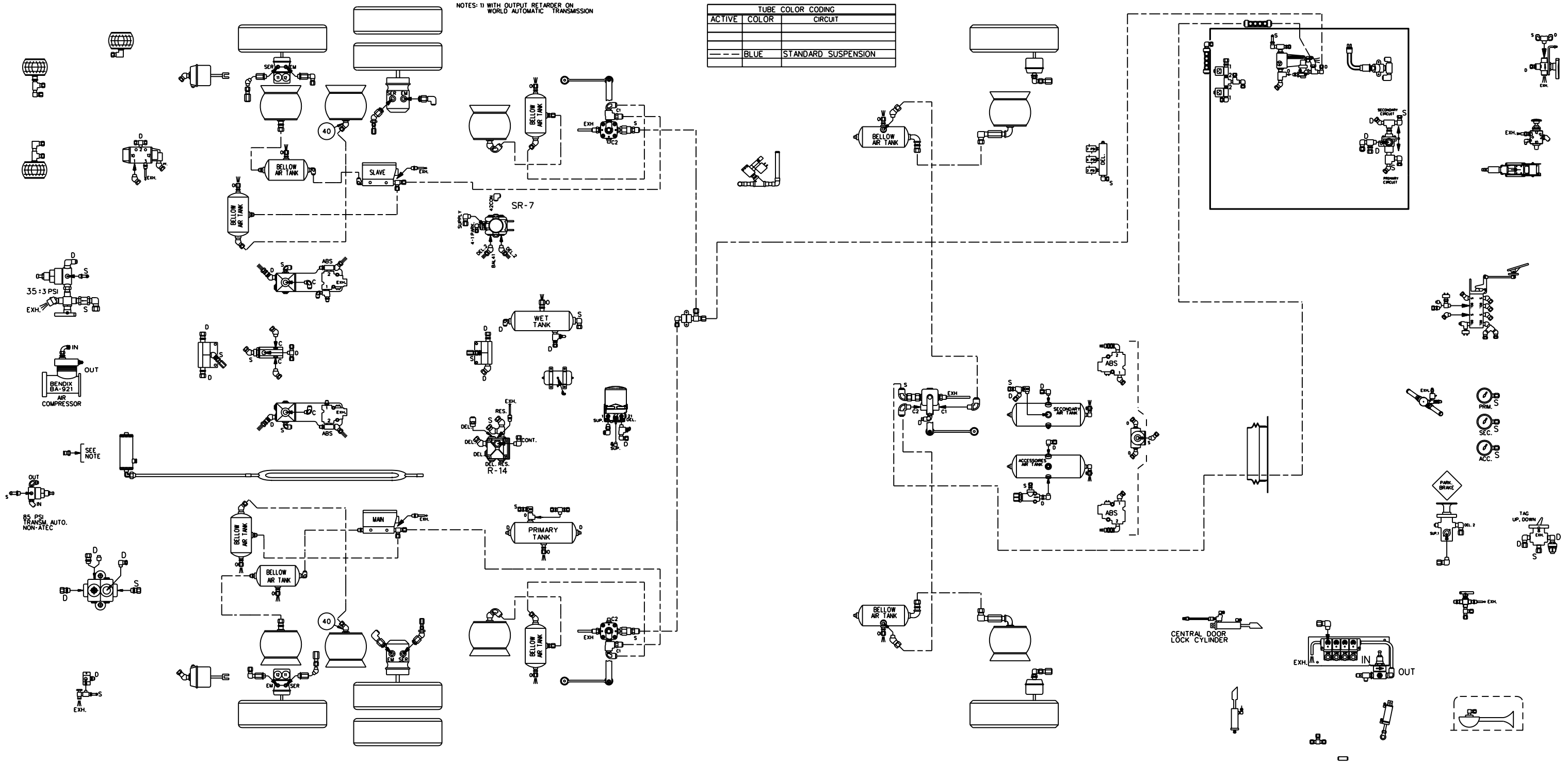

**PREVOST**

DESCRIPTION:  
X3-45 COACH, WITH INDEPENDENT FRONT SUSPENSION (I.F.S.)  
STANDARD SUSPENSION

EFF. W/ VEH : #7-9035...  
DATE: 2006/08 REV.: B

PAGE:  
D140330 P1.4

NOTES: 1) WITH OUTPUT RETARDER ON WORLD AUTOMATIC TRANSMISSION

ACTIVE	COLOR	CIRCUIT
---	RED	SECONDARY
---	GREEN	PRIMARY & SUPPLY
---	YELLOW	PARKING BRAKES

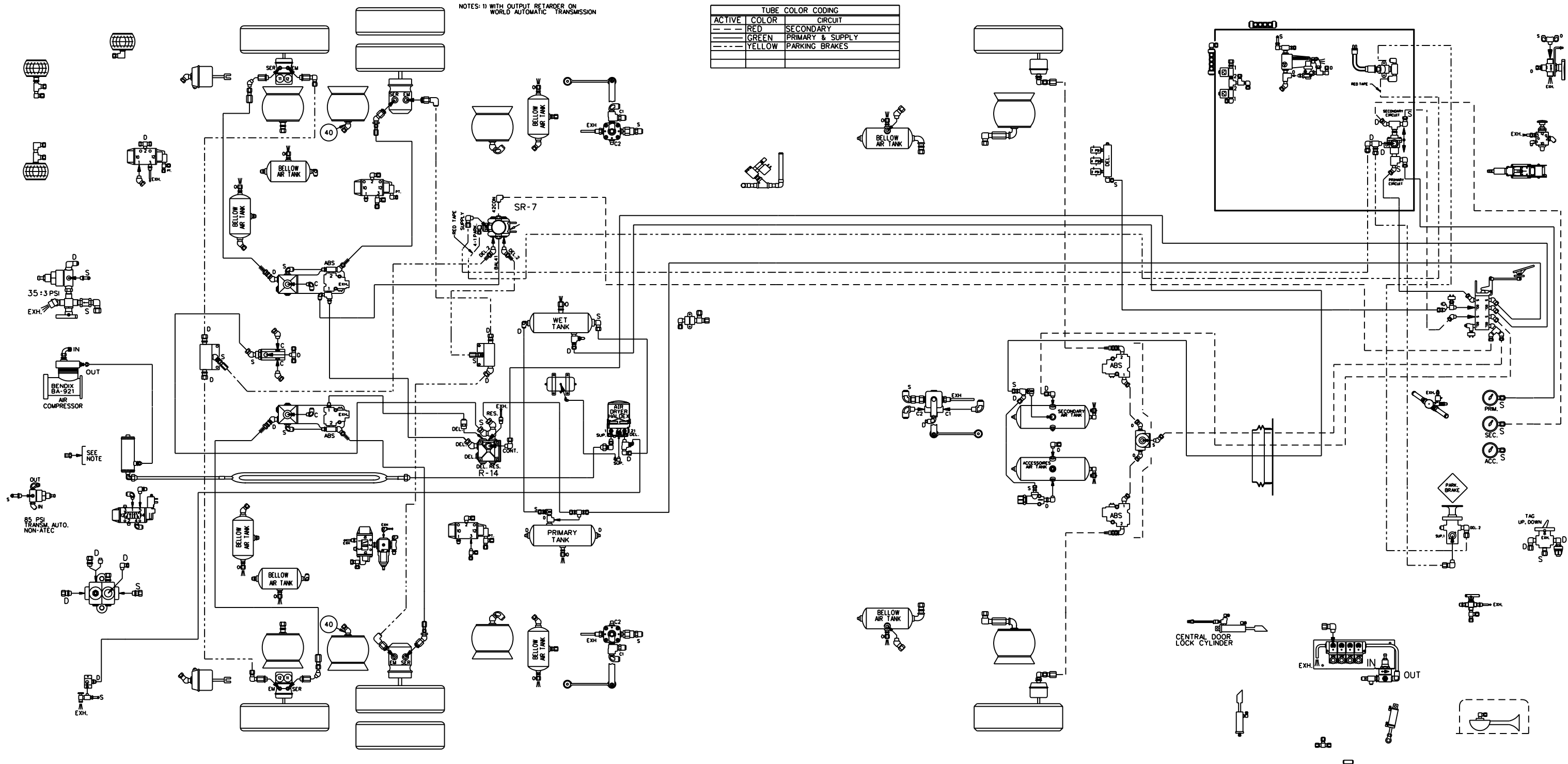

**PREVOST**®

DESCRIPTION:  
X3-45 COACH, WITH INDEPENDENT FRONT SUSPENSION (I.F.S.)  
BRAKES SYSTEM

EFF. W/ VEH : #8-9226...  
DATE: 2007/04 REV.: C

PAGE:  
D140330 P1.3

NOTES: 1) WITH OUTPUT RETARDER ON  
WORLD AUTOMATIC TRANSMISSION

TUBE COLOR CODING		
ACTIVE	COLOR	CIRCUIT
---	BLUE	STANDARD SUSPENSION

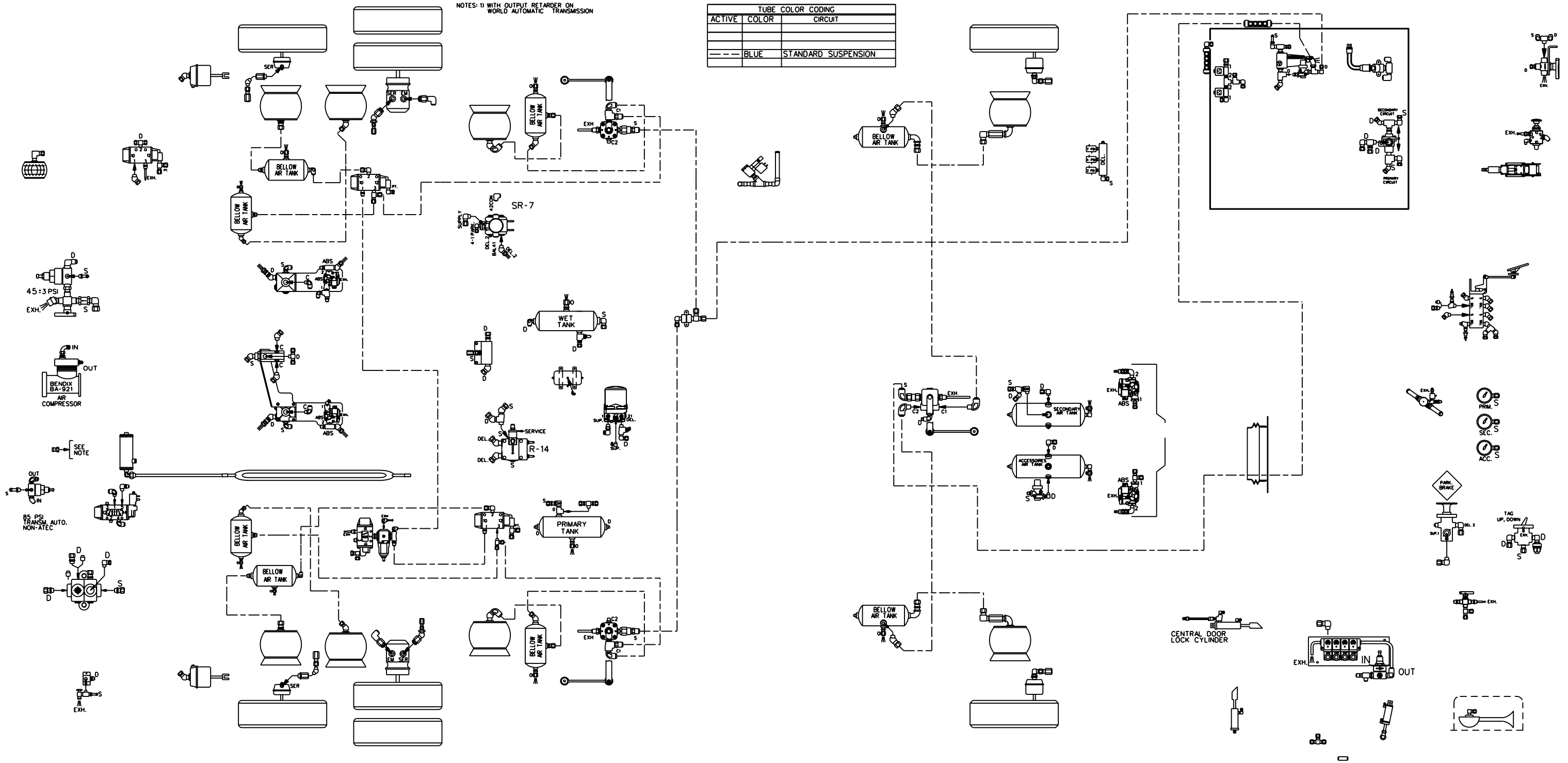

**PREVOST**®

DESCRIPTION:  
X3-45 COACH, WITH INDEPENDENT FRONT SUSPENSION (I.F.S.)  
STANDARD SUSPENSION

EFF. W/ VEH : #8-9295...  
DATE: 2007/07 REV.: D

PAGE:  
D140330 P1.4

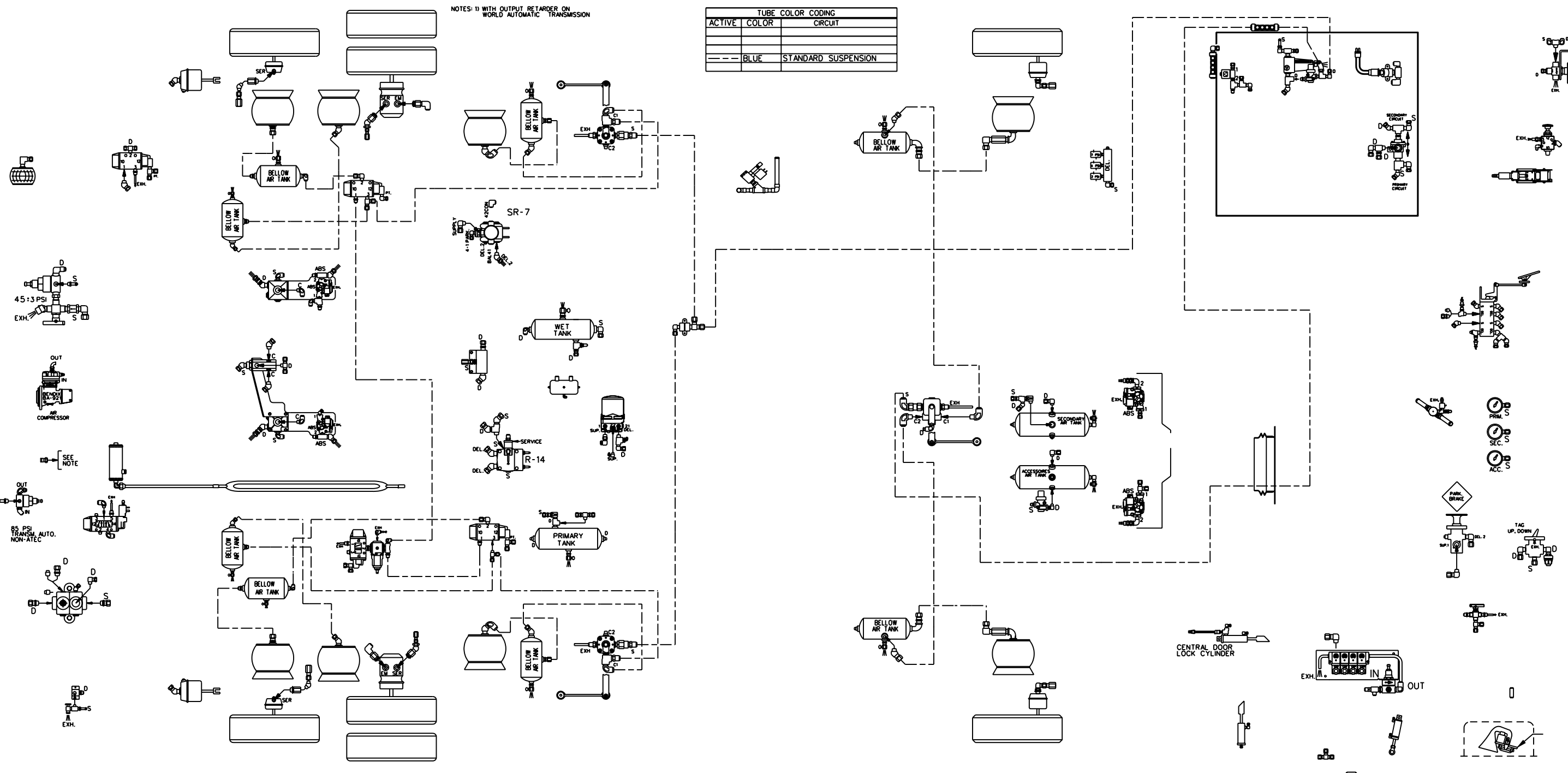

**PREVOST.**

DESCRIPTION:  
X3-45 COACH, WITH INDEPENDENT FRONT SUSPENSION (I.F.S.)  
STANDARD SUSPENSION

EFF. W/ VEH : #8-9422...  
DATE: 2008/03 REV.: F

PAGE:  
D140330 P1.4



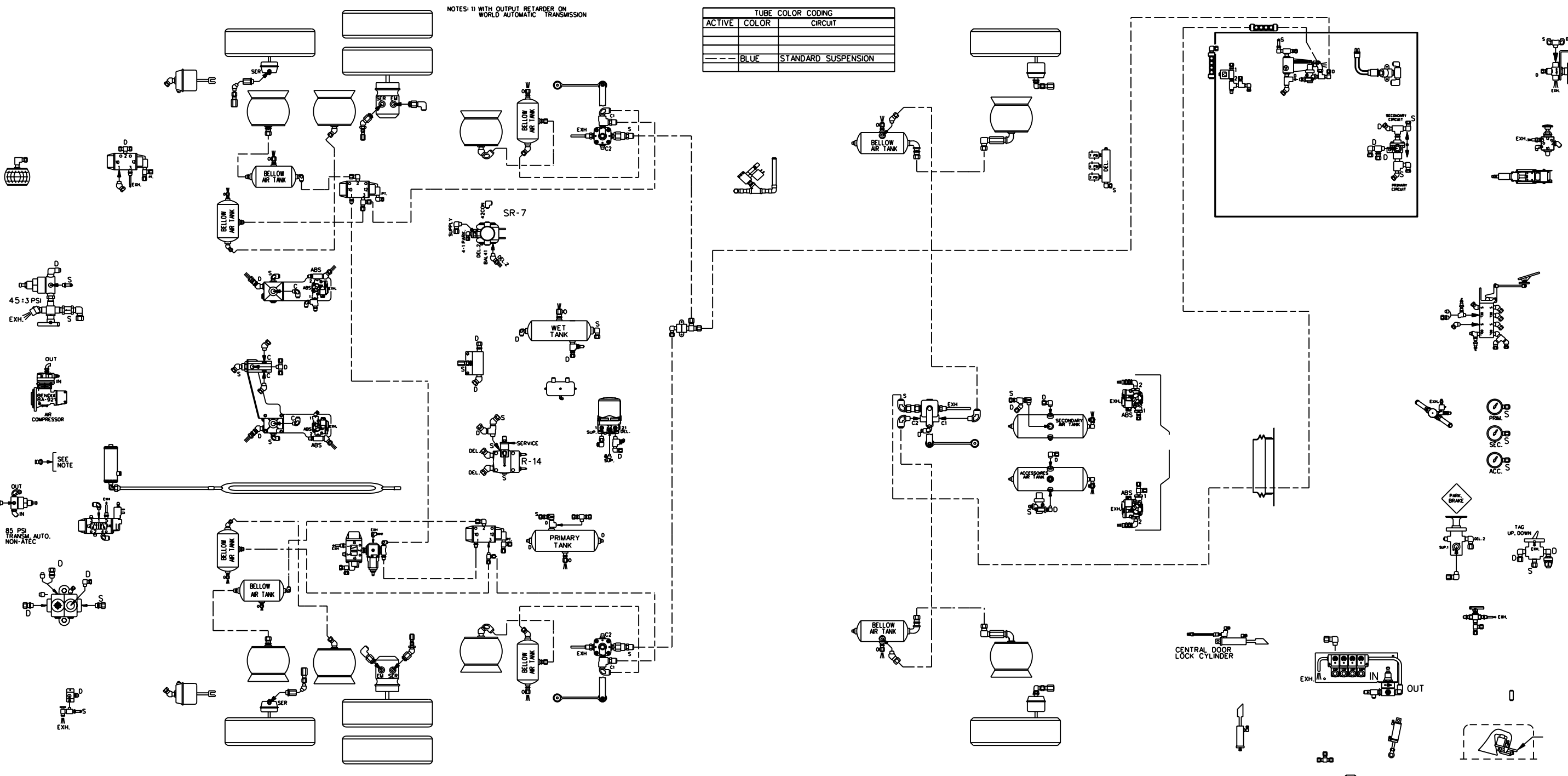

**PREVOST.**

DESCRIPTION:  
 X3-45 COACH, WITH INDEPENDENT FRONT SUSPENSION (I.F.S.)  
 STANDARD SUSPENSION

EFF. W/ VEH : #9-9504  
 DATE: 2008/04  
 REV.: G

PAGE:  
 D140330 P1.4

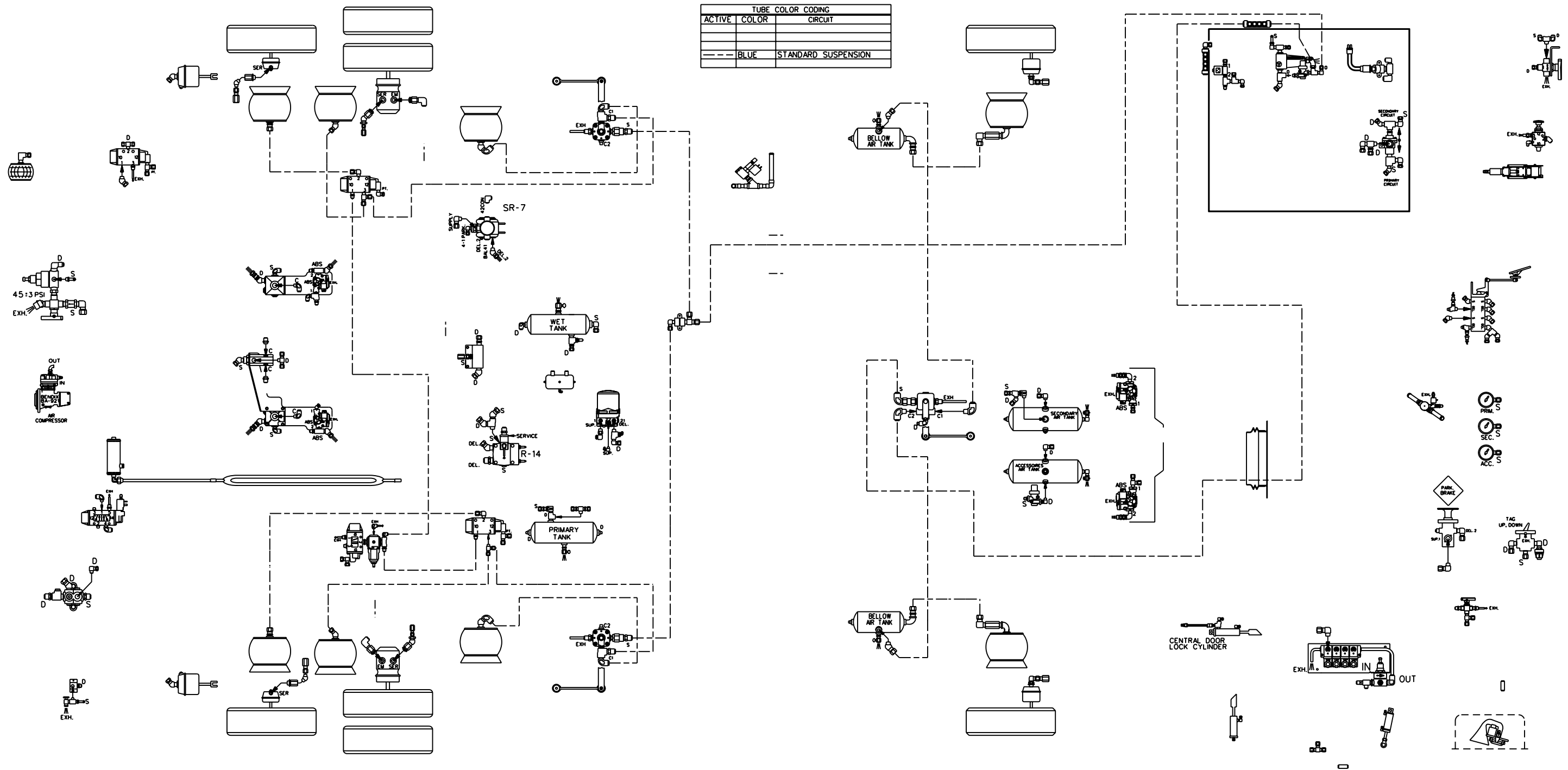

**PREVOST**®

DESCRIPTION:  
 X3-45 COACH, WITH INDEPENDENT FRONT SUSPENSION (I.F.S.)  
 STANDARD SUSPENSION

EFF. W/ VEH : #9-9599...  
 DATE: 2008/07 REV.: H

PAGE:  
 D140330 P1.4

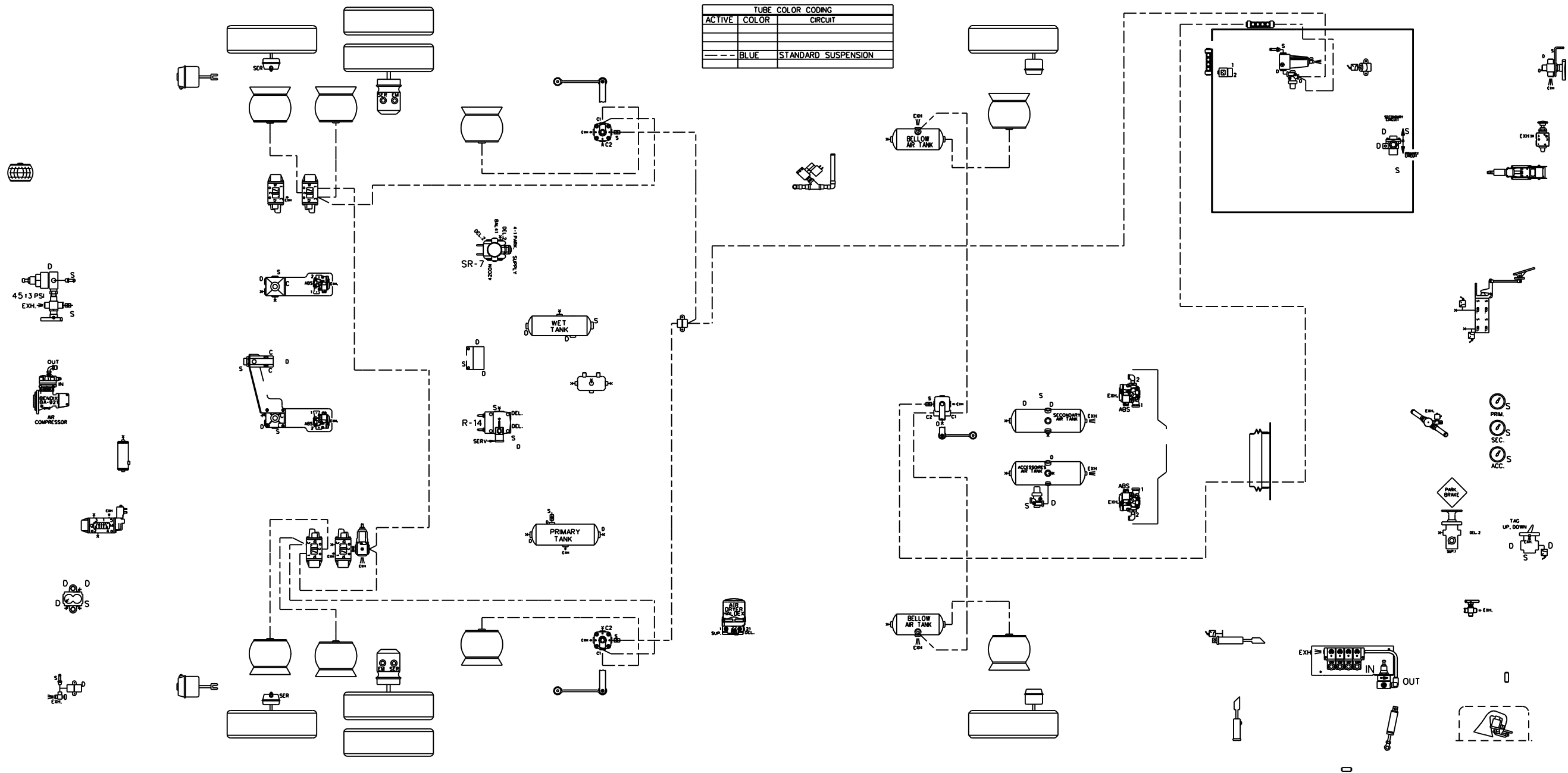

**PREVOST**

DESCRIPTION:  
X3-45 COACH, WITH INDEPENDENT FRONT SUSPENSION (I.F.S.)  
STANDARD SUSPENSION

EFF. W/ VEH : #A-9953

DATE: 2010/04

REV.: i

PAGE:

D140330 P1.4

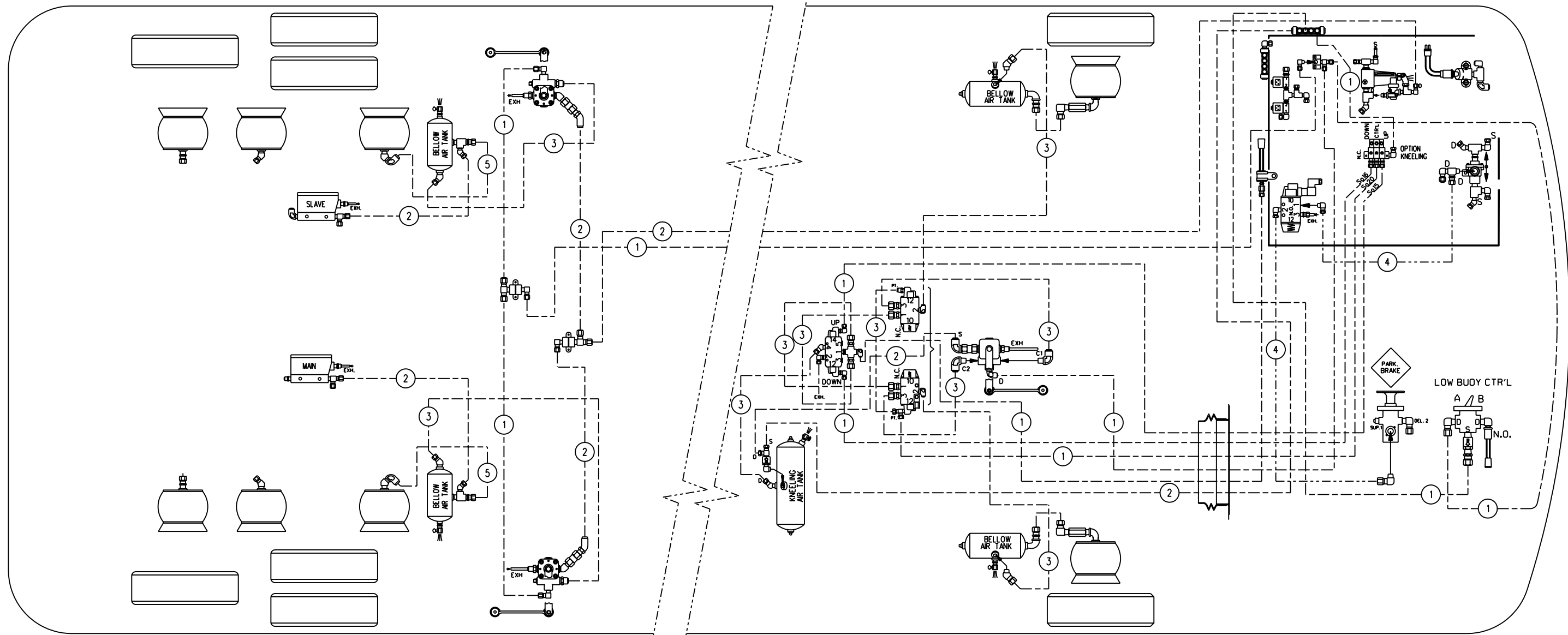

KNEELING SYSTEM = UP (CTR'L + UP ENERGIZED)  
DOWN (CTR'L + DOWN ENERGIZED)

BALLOON	PIPE
*1	1/4" O.D. BLUE
*2	3/8" O.D. BLUE
*3	1/2" O.D. BLUE
*4	3/8" O.D. YELLOW
*5	3/4" O.D. BLACK

TUBE COLOR CODING		
LINE TYPE	COLOR	CIRCUIT
---	BLUE	SUSPENSION
---	YELLOW	PARKING BRAKES

NOTE:

CONTROL VALVE OPT. "LOW-BUOY" , "A" OR "B" SETTING:

POSITION "A": VALVE IS OPEN,  
AIR FLOW BETWEEN SUPPLY (S) AND  
DELIVERY (D) , LOW-BUOY IS IN FUNCTION.

POSITION "B": VALVE CLOSED,  
AIR DOES'NT FLOW BETWEEN SUPPLY (S) AND  
DELIVERY (D) , LOW-BUOY IS NOT IN FUNCTION.

**PREVOST**®

DESCRIPTION:

X3-45 COACH, WITH INDEPENDENT FRONT SUSPENSION (I.F.S.) WITH  
OPTION FRONT KNEELING & LOW-BUOY COMBINATION

EFF.W/ VEH.

TO FOLLOW

PAGE:

DATE:  
2006/03

REV.:  
A

D140330 P2.1

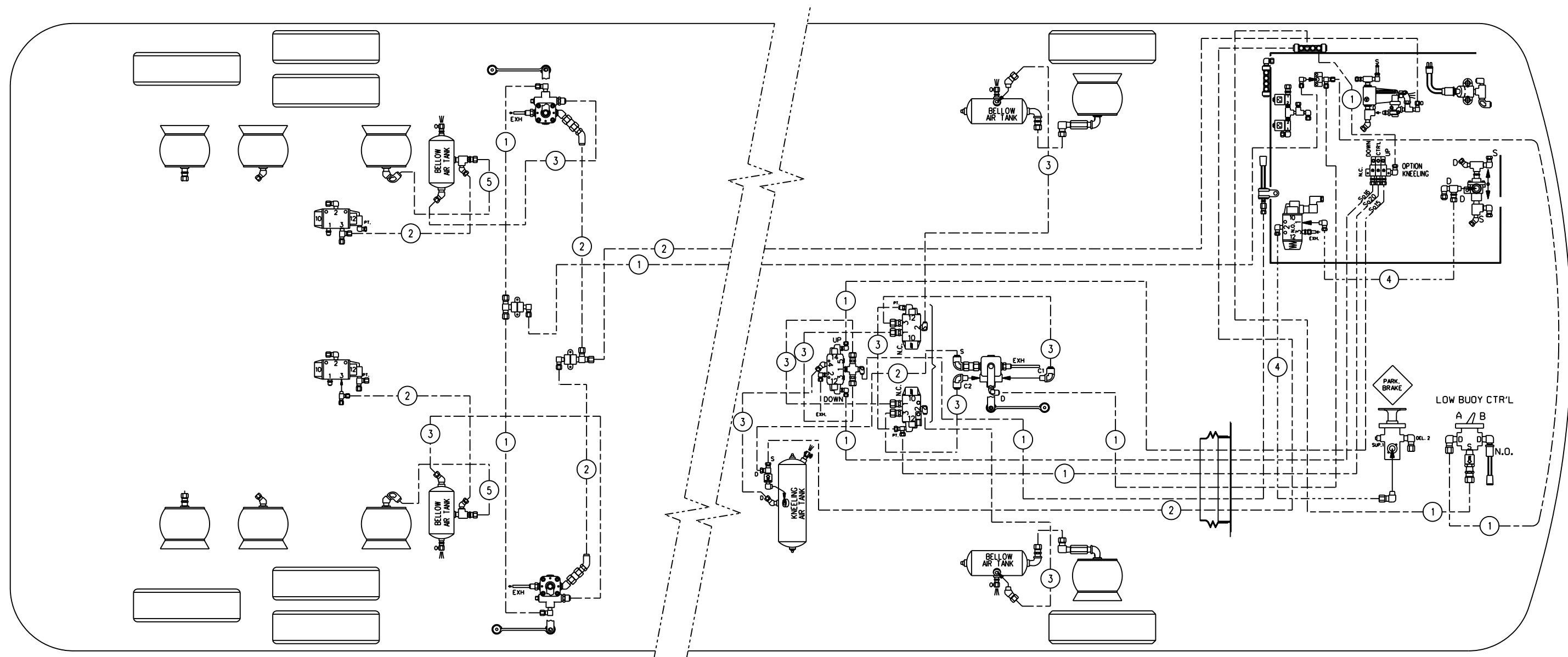

KNEELING SYSTEM = UP (CTR'L + UP ENERGIZED)  
DOWN (CTR'L + DOWN ENERGIZED)

BALLOON	PIPE
*1	1/4" O.D. BLUE
*2	3/8" O.D. BLUE
*3	1/2" O.D. BLUE
*4	3/8" O.D. YELLOW
*5	3/4" O.D. BLACK

TUBE COLOR CODING		
LINE TYPE	COLOR	CIRCUIT
---	BLUE	SUSPENSION
---	YELLOW	PARKING BRAKES

NOTE:

CONTROL VALVE OPT. "LOW-BUOY" , "A" OR "B" SETTING:

POSITION "A": VALVE IS OPEN,  
AIR FLOW BETWEEN SUPPLY (S) AND  
DELIVERY (D) , LOW-BUOY IS IN FUNCTION.

POSITION "B": VALVE CLOSED,  
AIR DOES'NT FLOW BETWEEN SUPPLY (S) AND  
DELIVERY (D) , LOW-BUOY IS NOT IN FUNCTION.

**PREVOST®**

DESCRIPTION:

X3-45 COACH, WITH INDEPENDENT FRONT SUSPENSION (I.F.S.) WITH  
OPTION FRONT KNEELING & LOW-BUOY COMBINATION

EFF.W/ VEH.

TO FOLLOW

PAGE:

D140330 P2.1

DATE:

2007/04

REV.:

B

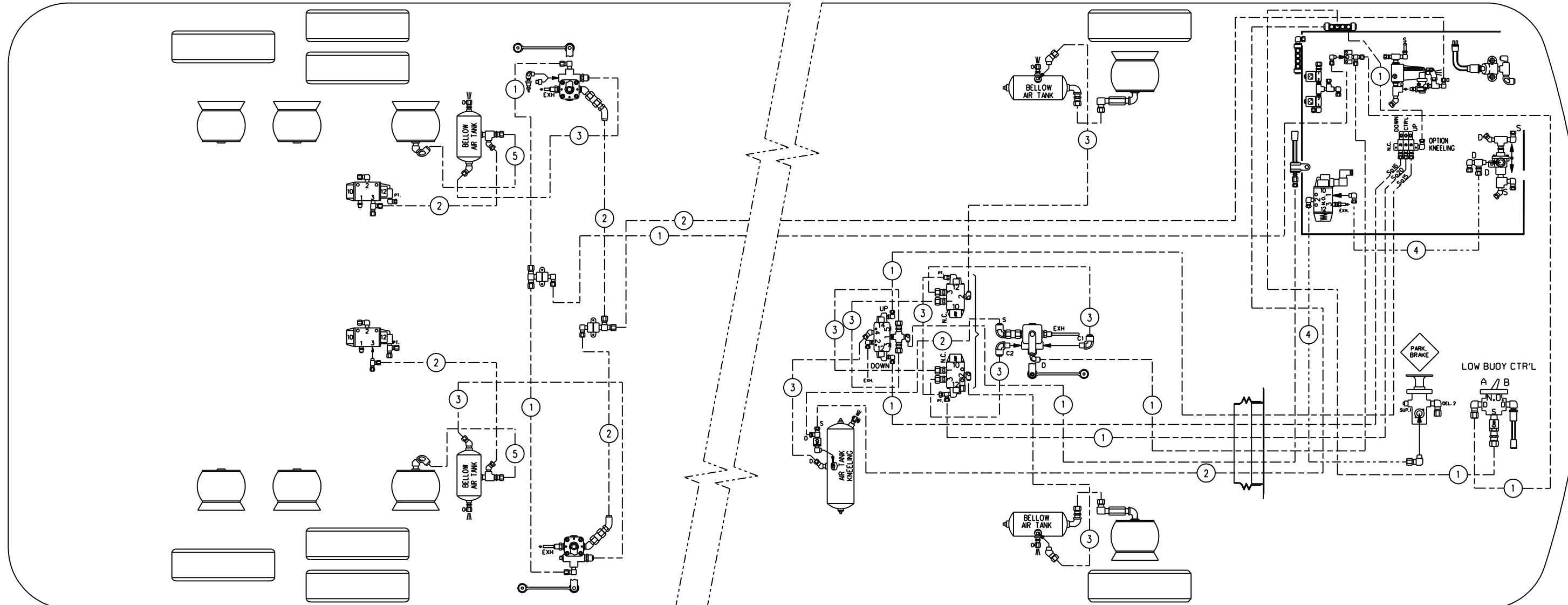

BALLOON	PIPE
*1	1/4" O.D. BLUE
*2	3/8" O.D. BLUE
*3	1/2" O.D. BLUE
*4	3/8" O.D. YELLOW
*5	3/4" O.D. BLACK

TUBE COLOR CODING		
LINE TYPE	COLOR	CIRCUIT
---	BLUE	SUSPENSION
---	YELLOW	PARKING BRAKES

**NOTE:**

CONTROL VALVE OPT. "LOW-BUOY" , "A" OR "B" SETTING:

POSITION "A": VALVE IS OPEN,  
AIR FLOW BETWEEN SUPPLY (S) AND  
DELIVERY (D) , LOW-BUOY IS IN FUNCTION.

POSITION "B": VALVE CLOSED,  
AIR DOES'NT FLOW BETWEEN SUPPLY (S) AND  
DELIVERY (D) , LOW-BUOY IS NOT IN FUNCTION.

**PREVOST®**

DESCRIPTION:  
X3-45 COACH, WITH INDEPENDENT FRONT SUSPENSION (I.F.S.) WITH  
OPTION FRONT KNEELING & LOW-BUOY COMBINATION

EFF.W/ VEH. #8-9288

DATE: 2007/05

REV.: C

PAGE:  
D140330 P2.1

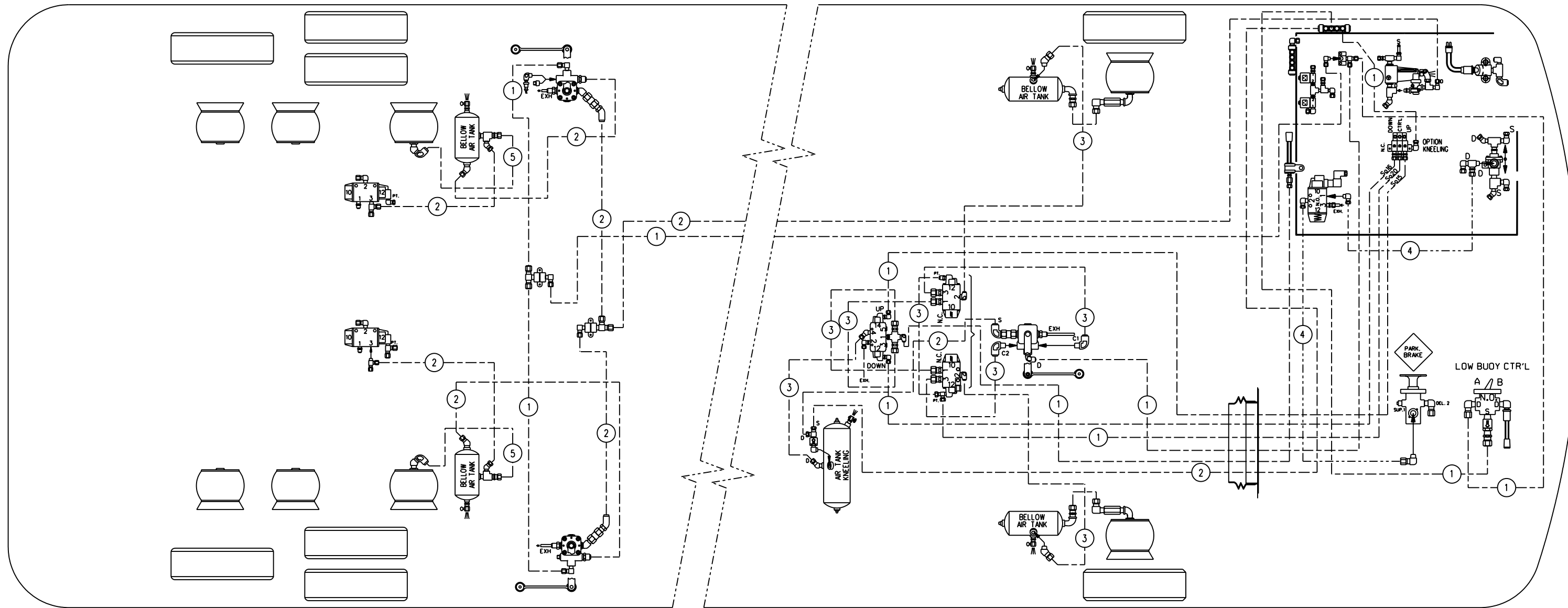

BALLOON	PIPE
*1	1/4" O.D. BLUE
*2	3/8" O.D. BLUE
*3	1/2" O.D. BLUE
*4	3/8" O.D. YELLOW
*5	3/4" O.D. BLACK

TUBE COLOR CODING		
LINE TYPE	COLOR	CIRCUIT
---	BLUE	SUSPENSION
---	YELLOW	PARKING BRAKES

**NOTE:**

CONTROL VALVE OPT. "LOW-BUOY" , "A" OR "B" SETTING:

POSITION "A": VALVE IS OPEN,  
AIR FLOW BETWEEN SUPPLY (S) AND  
DELIVERY (D) , LOW-BUOY IS IN FUNCTION.

POSITION "B": VALVE CLOSED,  
AIR DOES'NT FLOW BETWEEN SUPPLY (S) AND  
DELIVERY (D) , LOW-BUOY IS NOT IN FUNCTION.

**PREVOST®**

DESCRIPTION:

X3-45 COACH, WITH INDEPENDENT FRONT SUSPENSION (I.F.S.) WITH  
OPTION FRONT KNEELING & LOW-BUOY COMBINATION

EFF.W/ VEH.

#8-9430

PAGE:

D140330 P2.1

DATE:

2008/04

REV.:

D

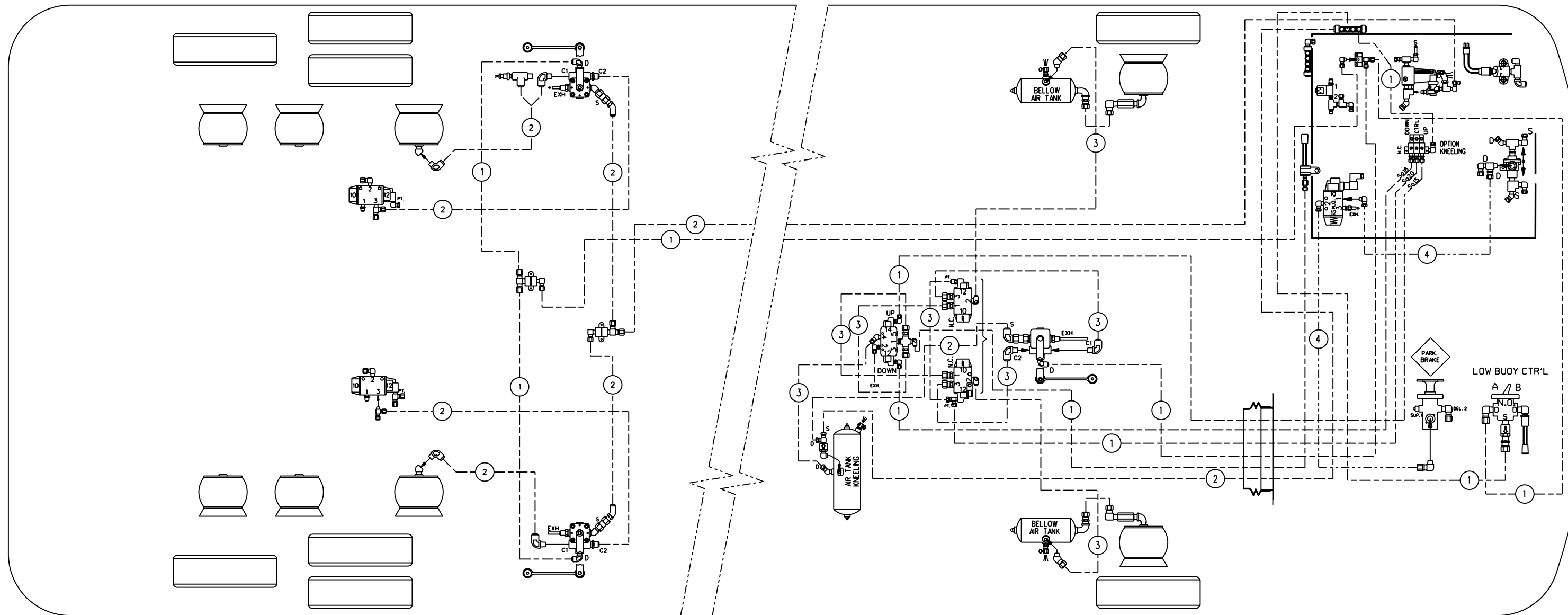

BALLOON	PIPE
#1	1/4" O.D. BLUE
#2	3/8" O.D. BLUE
#3	1/2" O.D. BLUE
#4	3/8" O.D. YELLOW

TUBE COLOR CODING		
LINE TYPE	COLOR	CIRCUIT
---	BLUE	SUSPENSION
---	YELLOW	PARKING BRAKES

**NOTE:**

CONTROL VALVE OPT. "LOW-BUOY" , "A" OR "B" SETTING:

POSITION "A": VALVE IS OPEN,  
AIR FLOW BETWEEN SUPPLY (S) AND  
DELIVERY (D) , LOW-BUOY IS IN FUNCTION.

POSITION "B": VALVE CLOSED,  
AIR DOES'NT FLOW BETWEEN SUPPLY (S) AND  
DELIVERY (D) , LOW-BUOY IS NOT IN FUNCTION.

**PREVOST.**

DESCRIPTION:

X3-45 COACH, WITH INDEPENDENT FRONT SUSPENSION (I.F.S.) WITH  
OPTION FRONT KNEELING & LOW-BUOY COMBINATION

EFF.W/ VEH.

#9-9599...

PAGE:

D140330 P2.1

DATE:

2008/07

REV.:

E



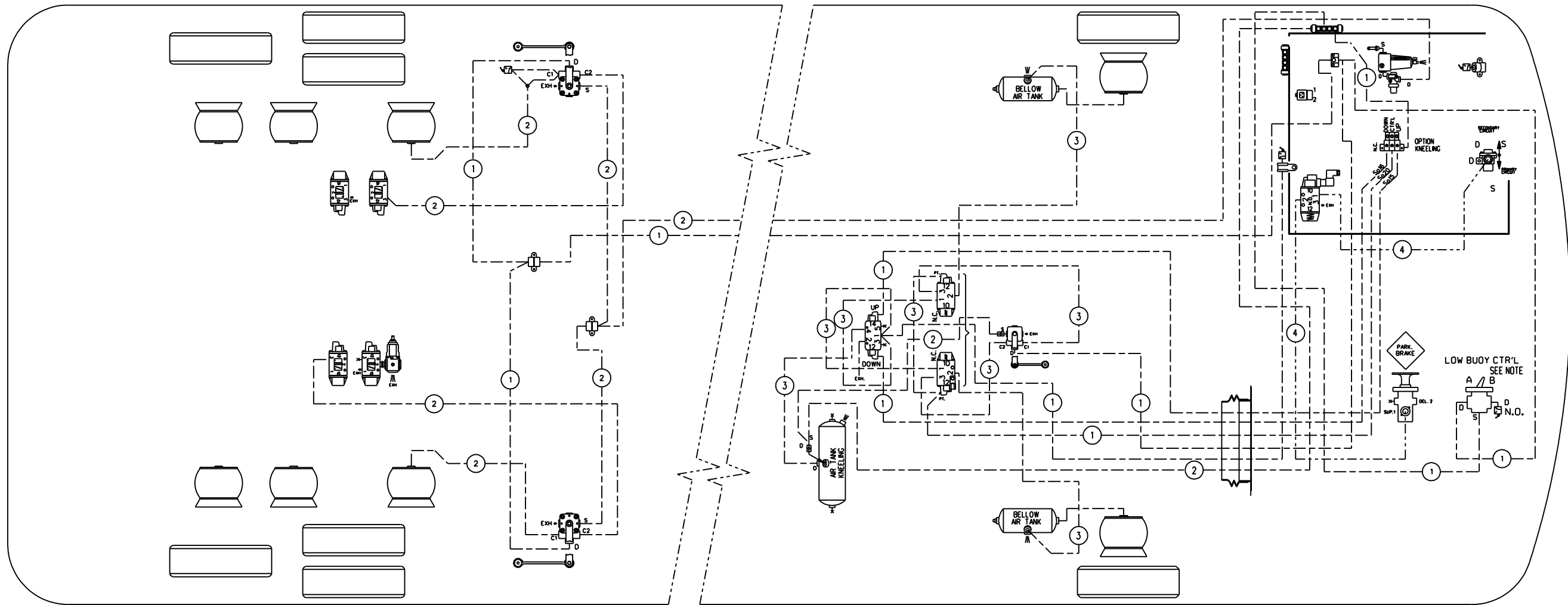

BALLOON	PIPE
*1	1/4" O.D. BLUE
*2	3/8" O.D. BLUE
*3	1/2" O.D. BLUE
*4	3/8" O.D. YELLOW

TUBE COLOR CODING		
LINE TYPE	COLOR	CIRCUIT
---	BLUE	SUSPENSION
---	YELLOW	PARKING BRAKES

**NOTE:**

CONTROL VALVE OPT. "LOW-BUOY" , "A" OR "B" SETTING:

**POSITION "A":** VALVE IS OPEN,  
AIR FLOW BETWEEN SUPPLY (S) AND  
DELIVERY (D) , LOW-BUOY IS IN FUNCTION.

**POSITION "B":** VALVE CLOSED,  
AIR DOES'NT FLOW BETWEEN SUPPLY (S) AND  
DELIVERY (D) , LOW-BUOY IS NOT IN FUNCTION.

**PREVOST**

DESCRIPTION:  
X3-45 COACH, WITH INDEPENDENT FRONT SUSPENSION (I.F.S.) WITH  
OPTION FRONT KNEELING & LOW-BUOY COMBINATION

EFF.W/ VEH.

#A-9953

PAGE:

D140330 P2.1

DATE: 2010/04

REV.: F

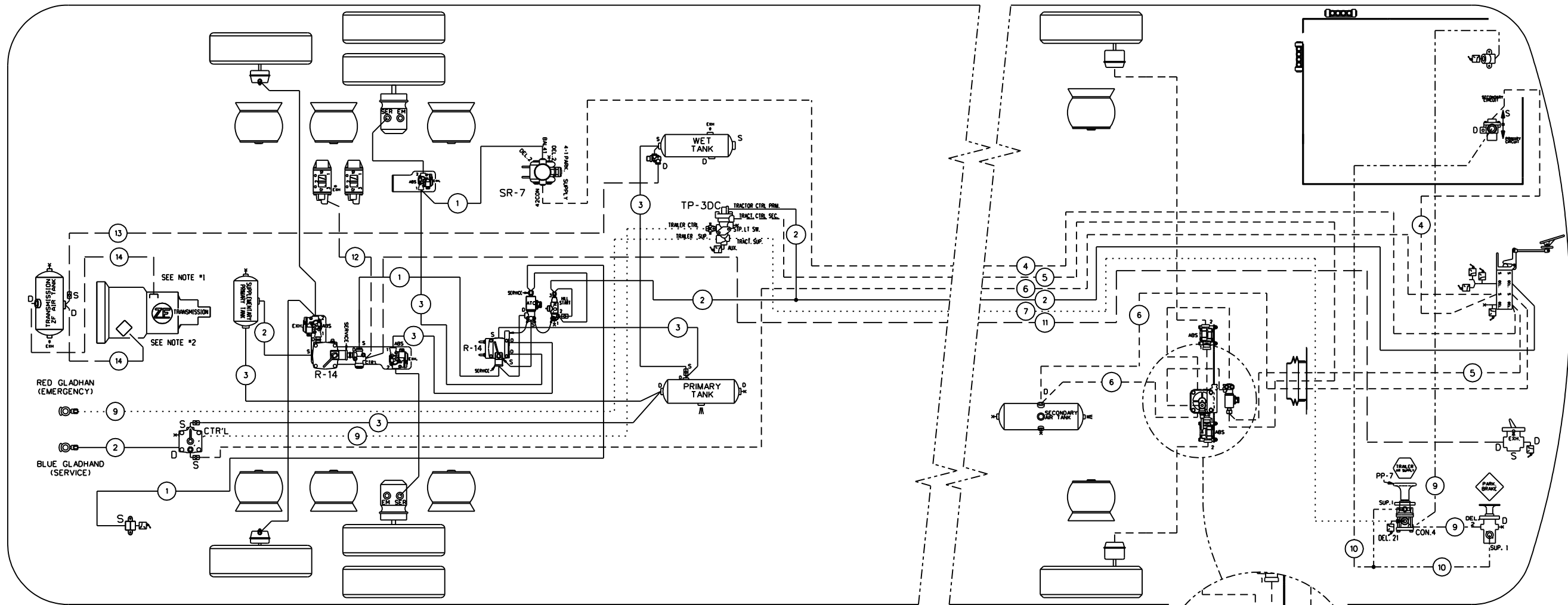

RED GLADHAN  
(EMERGENCY)

BLUE GLADHAN  
(SERVICE)

SEE NOTE #1

SEE NOTE #2

BALLOON	PIPE
*1	3/8" O.D. GREEN
*2	1/2" O.D. GREEN
*3	5/8" O.D. GREEN
*4	3/4" O.D. GREEN
*5	3/8" O.D. RED
*6	1/2" O.D. RED
*7	5/8" O.D. RED
*8	3/8" O.D. BROWN
*9	1/2" O.D. BROWN
*10	1/4" O.D. YELLOW
*11	3/8" O.D. YELLOW
*12	1/4" O.D. BLACK
*13	3/8" O.D. BLACK
*14	5/8" O.D. BLACK

TUBE COLOR CODING	
ACTIVE	COLOR
---	RED
---	GREEN
---	YELLOW
---	BROWN
---	BLACK
---	SECONDARY
---	PRIMARY & SUPPLY
---	PARKING BRAKE
---	TRAILER
---	ACCESSORIES

NOTE \*1: COMPRESSED AIR LINE FOR CLUTCH ACTUATOR  
\*2: COMPRESSED AIR LINE FOR TRANSMISSION ACTUATOR

**PREVOST**

DESCRIPTION:  
X3-45 COACH, WITH INDEPENDENT FRONT SUSPENSION (I.F.S.)  
WITH ZF TRANSMISSION & TRAILER HITCH OPTION

EFF. W/VEH : #A-9953...  
DATE: 2010/05 REV.: F

PAGE:  
D140330 SP2.1

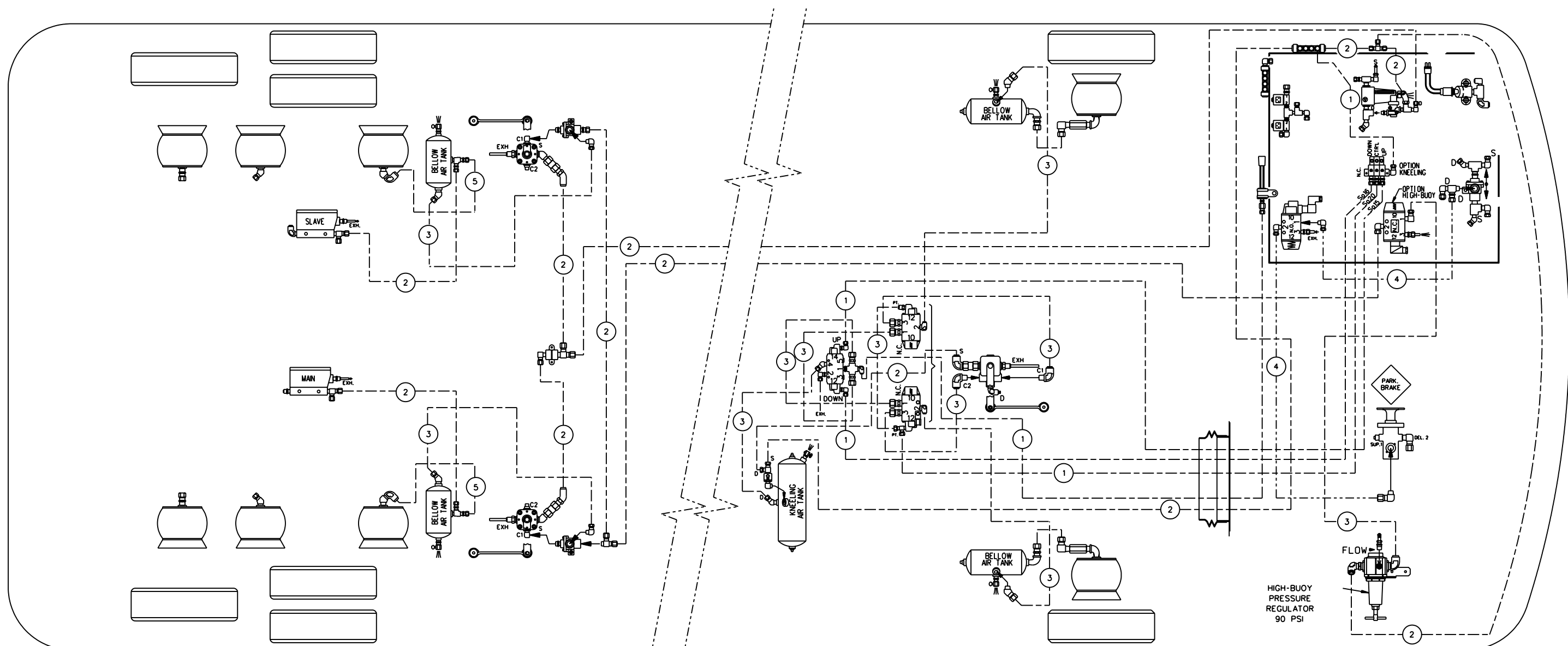

KNEELING SYSTEM = UP (CTR'L + UP ENERGIZED)  
 DOWN (CTR'L + DOWN ENERGIZED)

BALLOON	PIPE
*1	1/4" O.D. BLUE
*2	3/8" O.D. BLUE
*3	1/2" O.D. BLUE
*4	3/8" O.D. YELLOW
*5	3/4" O.D. BLACK

TUBE COLOR CODING		
LINE TYPE	COLOR	CIRCUIT
---	BLUE	SUSPENSION
---	YELLOW	PARKING BRAKES

**PREVOST®**

DESCRIPTION:

X3-45 COACH, WITH INDEPENDENT FRONT SUSPENSION (I.F.S.) WITH  
 OPTION FRONT KNEELING & HIGH-BUOY COMBINATION.

EFF. W/ VEH :

TO FOLLOW

DATE:

2006/03

REV.:

A

PAGE:

D140330 P3.1

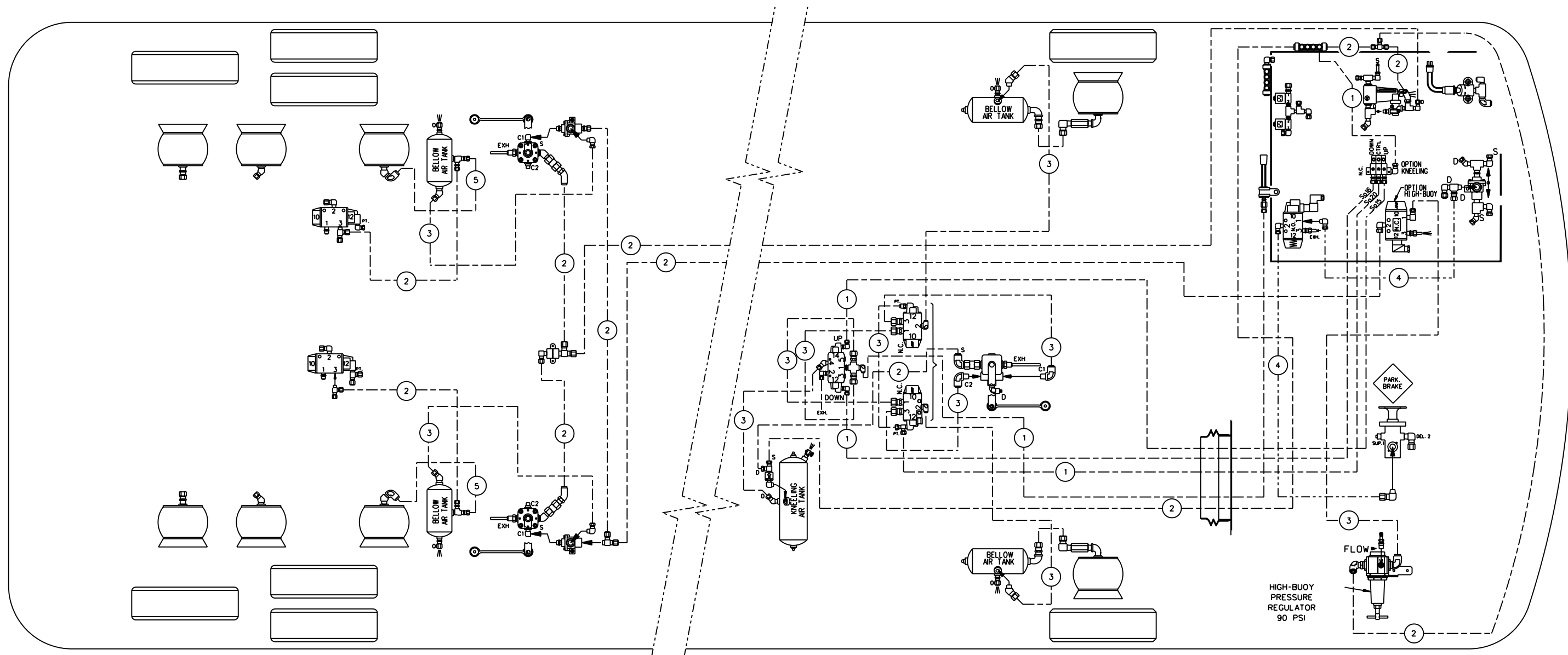

KNEELING SYSTEM = UP (CTR'L + UP ENERGIZED)  
DOWN (CTR'L + DOWN ENERGIZED)

BALLOON	PIPE
*1	1/4" O.D. BLUE
*2	3/8" O.D. BLUE
*3	1/2" O.D. BLUE
*4	3/8" O.D. YELLOW
*5	3/4" O.D. BLACK

TUBE COLOR CODING		
LINE TYPE	COLOR	CIRCUIT
---	BLUE	SUSPENSION
---	YELLOW	PARKING BRAKES

**PREVOST**®

DESCRIPTION:

X3-45 COACH, WITH INDEPENDENT FRONT SUSPENSION (I.F.S.) WITH  
OPTION FRONT KNEELING & HIGH-BUOY COMBINATION.

EFF. W/ VEH :

#7-9073...

PAGE:

D140330 P3.1

DATE:

2007/04

REV.:

B

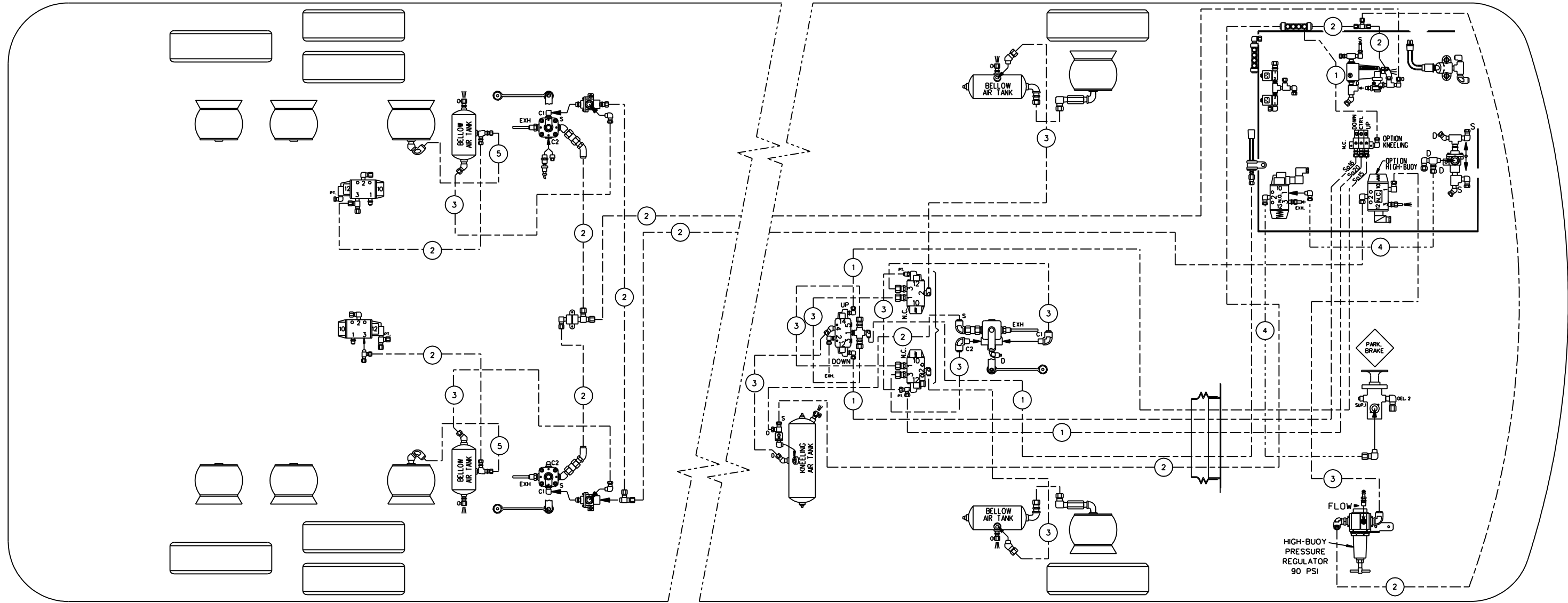

BALLOON	PIPE
*1	1/4" O.D. BLUE
*2	3/8" O.D. BLUE
*3	1/2" O.D. BLUE
*4	3/8" O.D. YELLOW
*5	3/4" O.D. BLACK

TUBE COLOR CODING		
LINE TYPE	COLOR	CIRCUIT
---	BLUE	SUSPENSION
---	YELLOW	PARKING BRAKES

**PREVOST®**

DESCRIPTION:  
 X3-45 COACH, WITH INDEPENDENT FRONT SUSPENSION (I.F.S.) WITH  
 OPTION FRONT KNEELING & HIGH-BUOY COMBINATION.

EFF. W/ VEH : #8-9288

DATE: 2007/06 REV.: C

PAGE:  
 D140330 P3.1

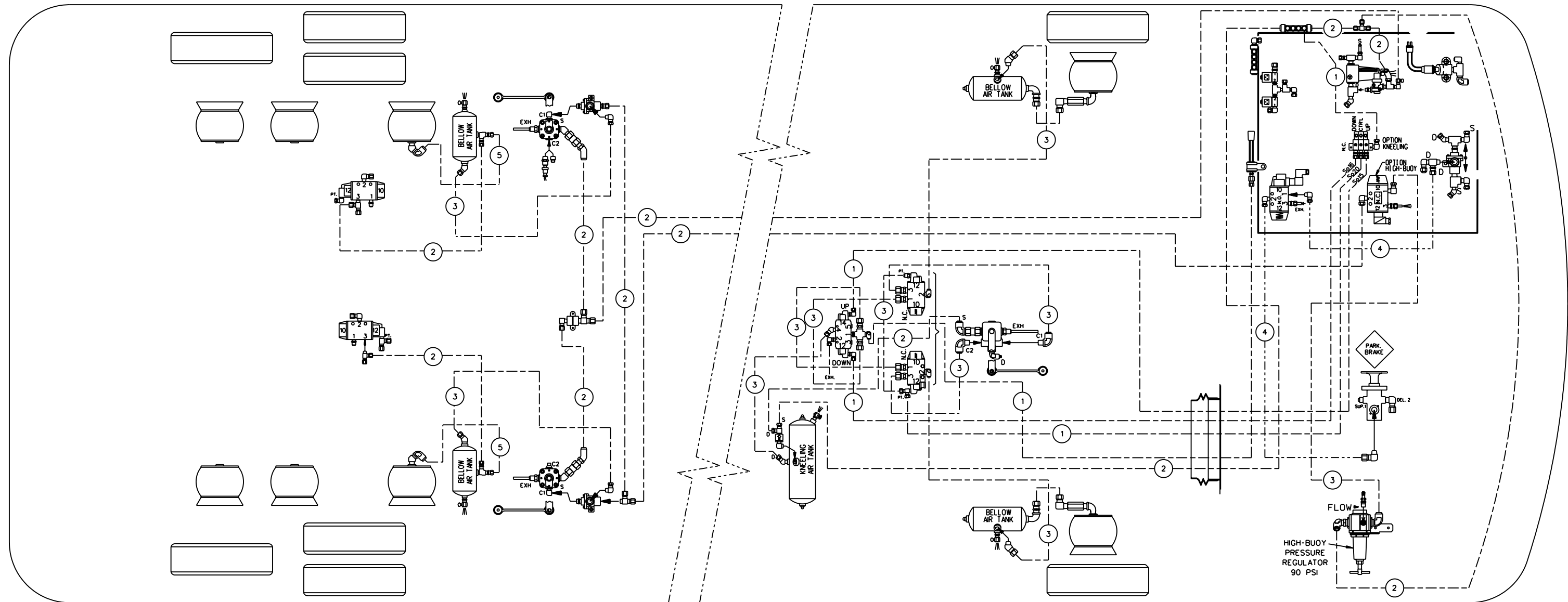

BALLOON	PIPE
#1	1/4" O.D. BLUE
#2	3/8" O.D. BLUE
#3	1/2" O.D. BLUE
#4	3/8" O.D. YELLOW
#5	3/4" O.D. BLACK

TUBE COLOR CODING		
LINE TYPE	COLOR	CIRCUIT
---	BLUE	SUSPENSION
---	YELLOW	PARKING BRAKES

**PREVOST®**

DESCRIPTION:

X3-45 COACH, WITH INDEPENDENT FRONT SUSPENSION (I.F.S.) WITH  
OPTION FRONT KNEELING & HIGH-BUOY COMBINATION.

EFF. W/ VEH :

#8-9430

PAGE:

D140330 P3.1

DATE:

2008/04

REV.:

D

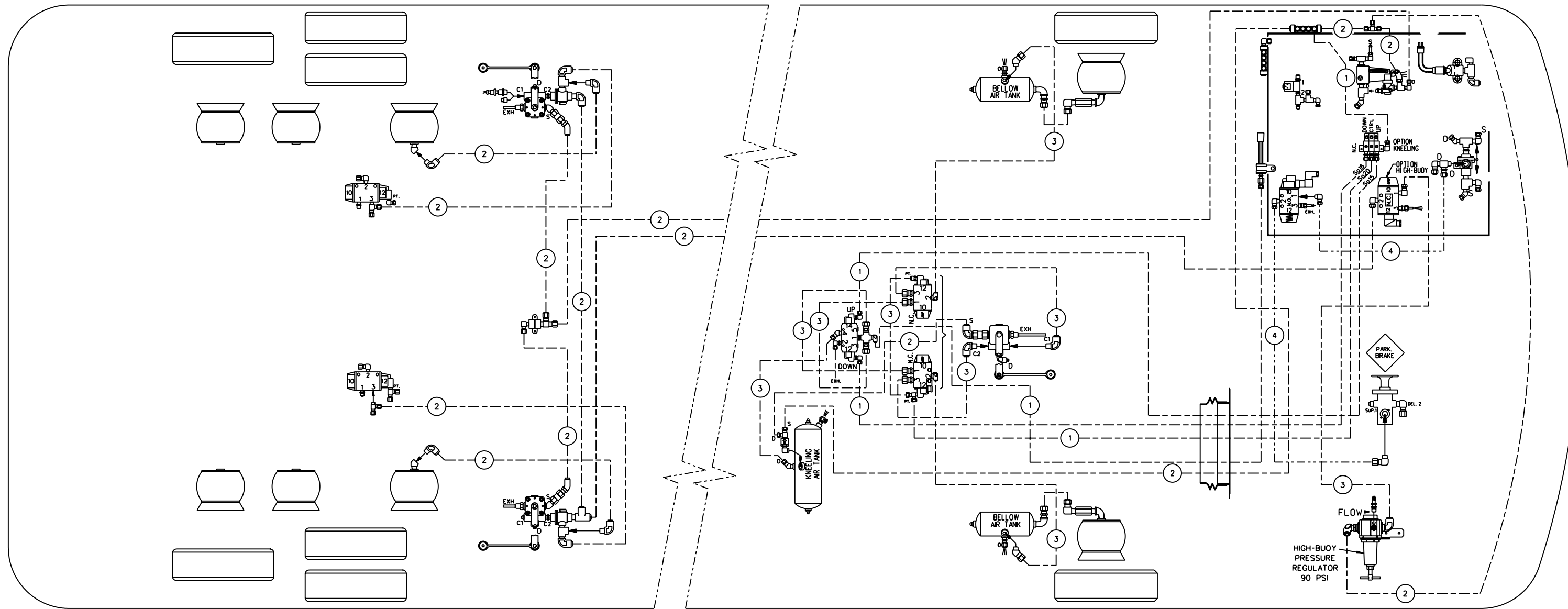

BALLOON	PIPE
*1	1/4" O.D. BLUE
*2	3/8" O.D. BLUE
*3	1/2" O.D. BLUE
*4	3/8" O.D. YELLOW

TUBE COLOR CODING		
LINE TYPE	COLOR	CIRCUIT
---	BLUE	SUSPENSION
---	YELLOW	PARKING BRAKES

**PREVOST**®

DESCRIPTION:

X3-45 COACH, WITH INDEPENDENT FRONT SUSPENSION (I.F.S.) WITH  
OPTION FRONT KNEELING & HIGH-BUOY COMBINATION.

EFF. W/ VEH :

#9-9599...

PAGE:

D140330 P3.1

DATE:

2008/07

REV.:

E

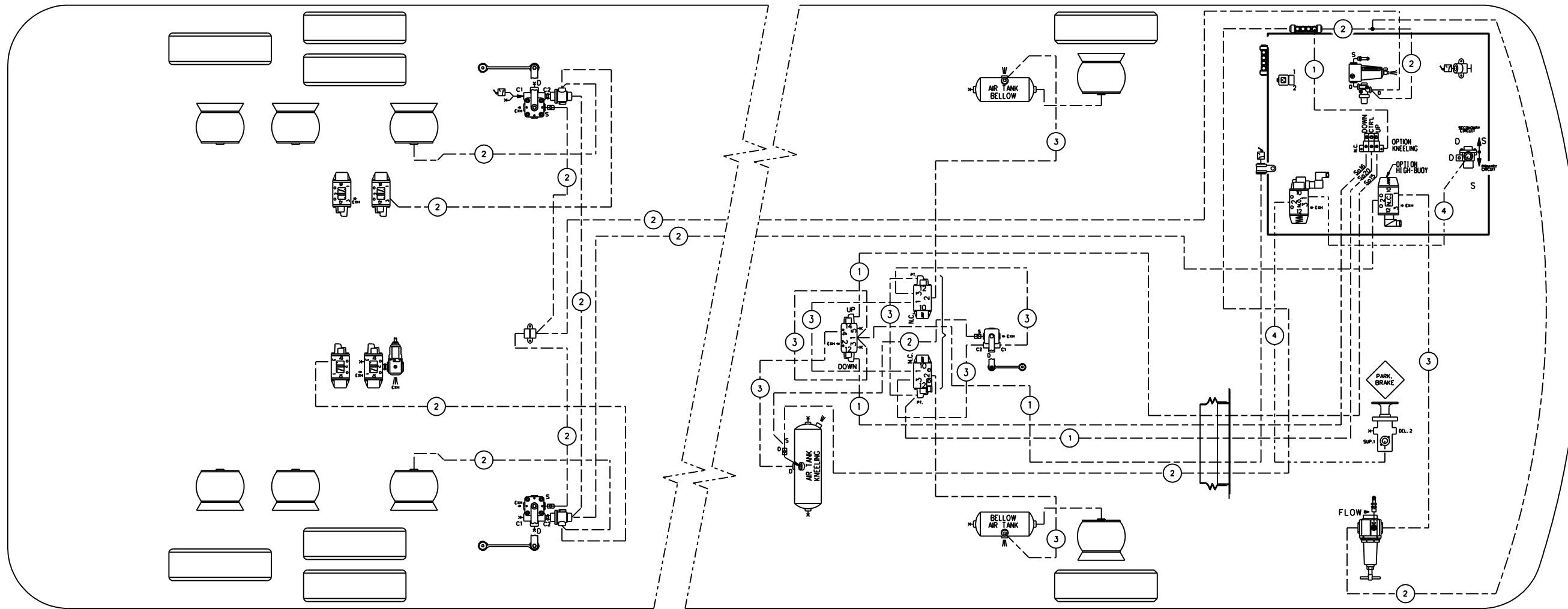

BALLOON	PIPE
*1	1/4" O.D. BLUE
*2	3/8" O.D. BLUE
*3	1/2" O.D. BLUE
*4	3/8" O.D. YELLOW

TUBE COLOR CODING		
LINE TYPE	COLOR	CIRCUIT
---	BLUE	SUSPENSION
---	YELLOW	PARKING BRAKES

**PREVOST**

DESCRIPTION:

X3-45 COACH, WITH INDEPENDENT FRONT SUSPENSION (I.F.S.) WITH OPTION FRONT KNEELING & HIGH-BUOY COMBINATION.

EFF. W/ VEH :

#A-9953

PAGE:

D140330 P3.1

DATE:

2010/04

REV.:

F



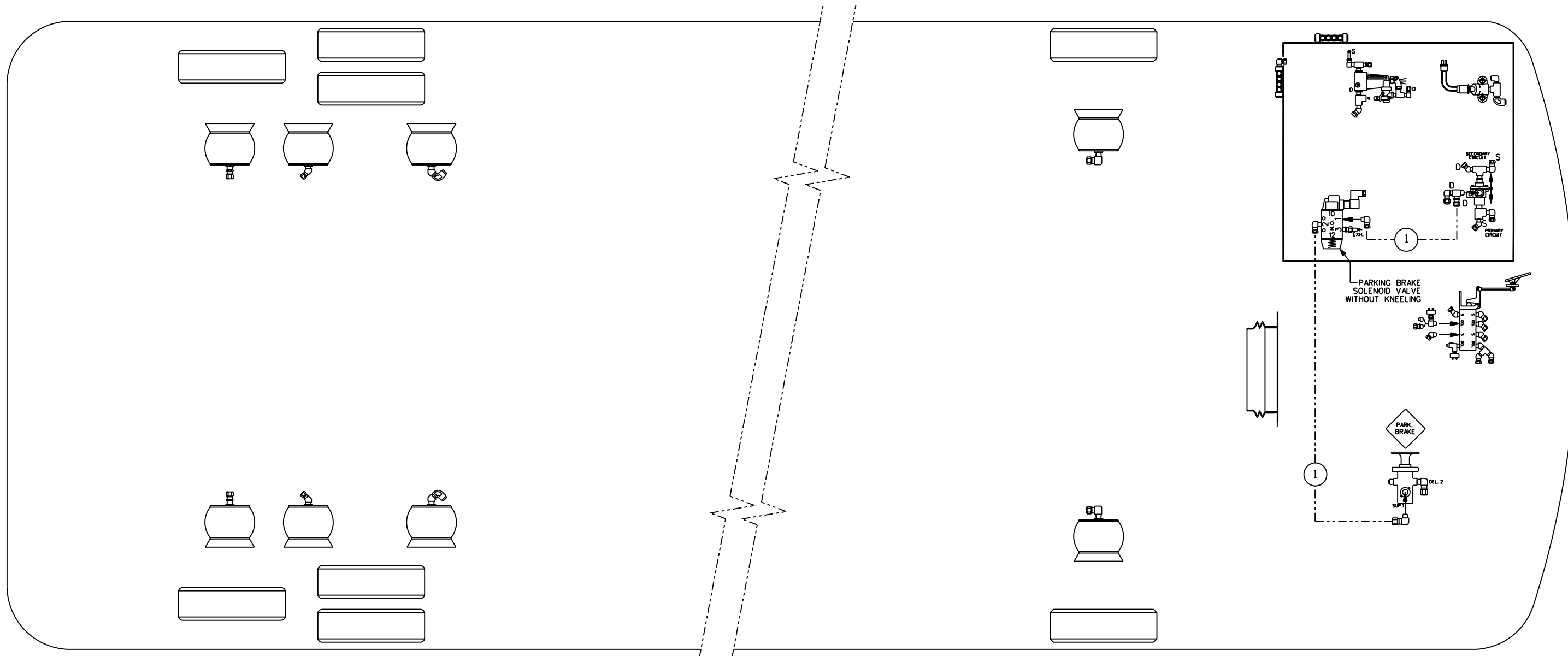

TUBE COLOR CODING		
ACTIVE	COLOR	CIRCUIT
---	YELLOW	PARKING BRAKE

BALLOON	PIPE
*1	1/4" O.D. YELLOW

**PREVOST®**

DESCRIPTION:  
 X3-45 COACH, WITH INDEPENDENT FRONT SUSPENSION (I.F.S.)  
 WITH OPTION PARKING BRAKE RELEASE WITH SUPPLEMENTARY  
 SWITCH (SPECIAL ORLEANS WITHOUT KNEELING)

EFF. W/ VEH :  
 #7-8883, #7-8952...  
 DATE: 2006/07  
 REV.: B

PAGE:  
 D140330 SP3.1

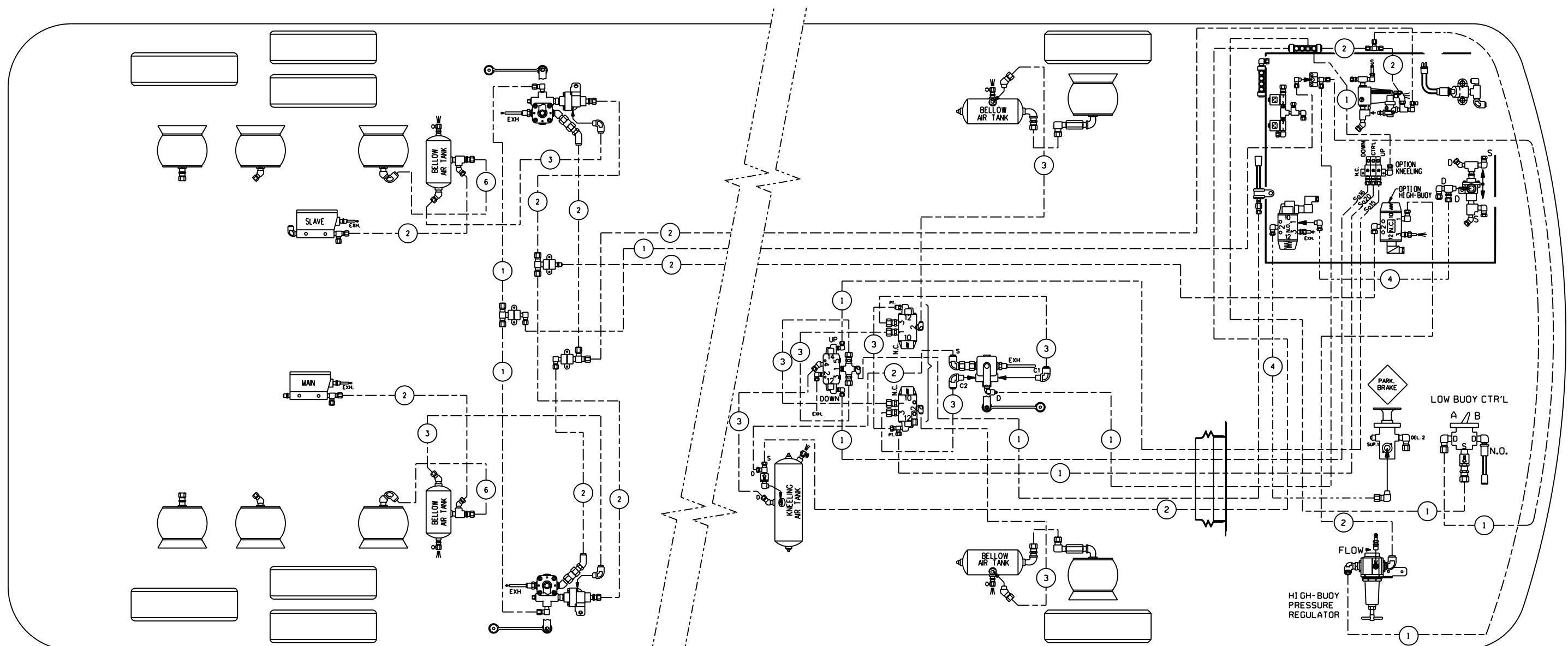

KNEELING SYSTEM = UP (CTR'L + UP ENERGIZED)  
DOWN (CTR'L + DOWN ENERGIZED)

BALLOON	PIPE
#1	1/4" O.D. BLUE
#2	3/8" O.D. BLUE
#3	1/2" O.D. BLUE
#4	3/8" O.D. YELLOW
#5	3/8" O.D. BLACK
#6	3/4" O.D. BLACK

TUBE COLOR CODING		
LINE TYPE	COLOR	CIRCUIT
---	BLUE	SUSPENSION
---	BLACK	ACCESSORIES
---	YELLOW	PARKING BRAKES

NOTE:

CONTROL VALVE OPT. "LOW-BUOY" , "A" OR "B" SETTING:

POSITION "A": VALVE IS OPEN,  
AIR FLOW BETWEEN SUPPLY (S) AND  
DELIVERY (D) , LOW-BUOY IS IN FUNCTION.

POSITION "B": VALVE CLOSED,  
AIR DOES'NT FLOW BETWEEN SUPPLY (S) AND  
DELIVERY (D) , LOW-BUOY IS NOT IN FUNCTION.

**PREVOST**®

DESCRIPTION:

X3-45 COACH, WITH INDEPENDENT FRONT SUSPENSION (I.F.S.) WITH  
OPTION FRONT KNEELING, LOW-BUOY & HIGH-BUOY COMBINATION

EFF. W/VEH. :

#7-8933...

PAGE:

D140330 P4.1

DATE:

2006/03

REV.:

A

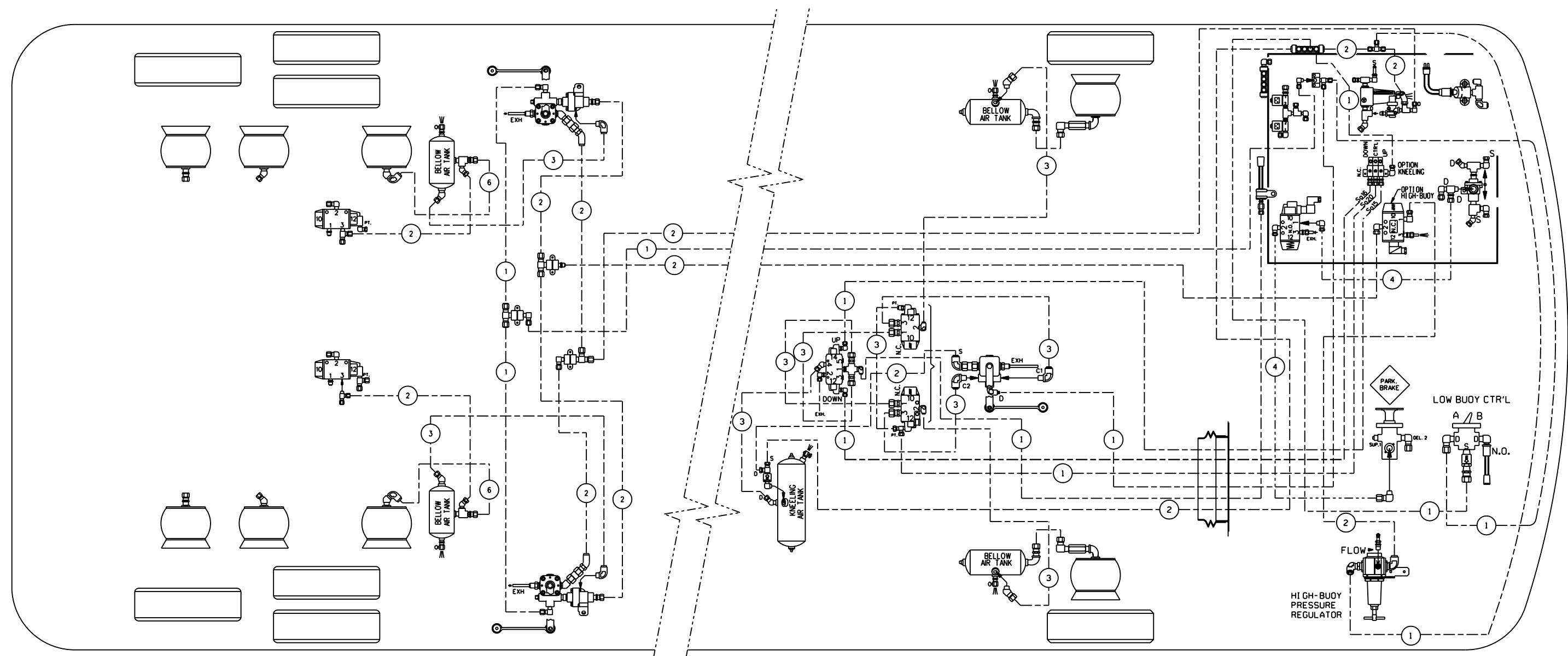

KNEELING SYSTEM = UP (CTR'L + UP ENERGIZED)  
DOWN (CTR'L + DOWN ENERGIZED)

BALLOON	PIPE
*1	1/4" O.D. BLUE
*2	3/8" O.D. BLUE
*3	1/2" O.D. BLUE
*4	3/8" O.D. YELLOW
*5	3/8" O.D. BLACK
*6	3/4" O.D. BLACK

TUBE COLOR CODING		
LINE TYPE	COLOR	CIRCUIT
---	BLUE	SUSPENSION
---	BLACK	ACCESSORIES
---	YELLOW	PARKING BRAKES

**NOTE:**

CONTROL VALVE OPT. "LOW-BUOY" , "A" OR "B" SETTING:

POSITION "A": VALVE IS OPEN,  
AIR FLOW BETWEEN SUPPLY (S) AND  
DELIVERY (D) , LOW-BUOY IS IN FUNCTION.

POSITION "B": VALVE CLOSED,  
AIR DOES'NT FLOW BETWEEN SUPPLY (S) AND  
DELIVERY (D) , LOW-BUOY IS NOT IN FUNCTION.

**PREVOST**

DESCRIPTION:

X3-45 COACH, WITH INDEPENDENT FRONT SUSPENSION (I.F.S.) WITH  
OPTION FRONT KNEELING, LOW-BUOY & HIGH-BUOY COMBINATION

EFF. W/VEH. :

#7-8933...

PAGE:

D140330 P4.1

DATE:

2007/04

REV.:

B

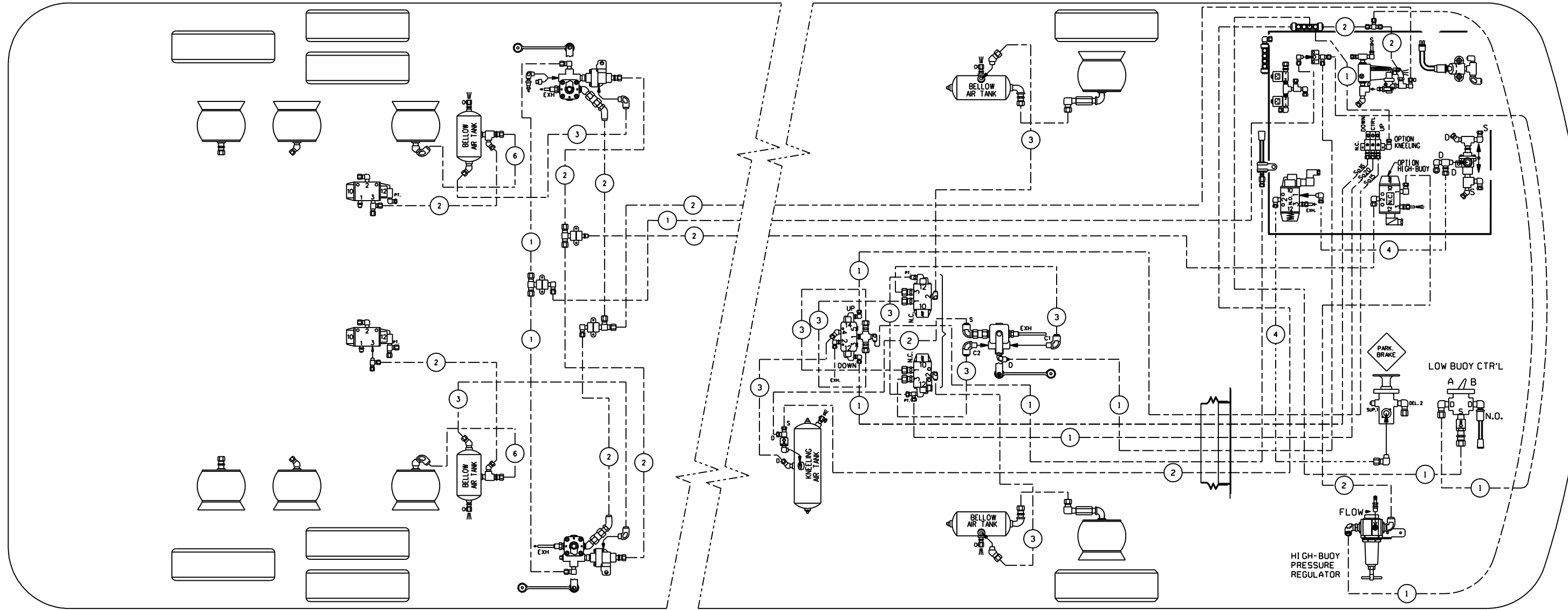

BALLOON	PIPE
*1	1/4" O.D. BLUE
*2	3/8" O.D. BLUE
*3	1/2" O.D. BLUE
*4	3/8" O.D. YELLOW
*5	3/8" O.D. BLACK
*6	3/4" O.D. BLACK

**NOTE:**

KNEELING SYSTEM = UP (CTR'L + UP ENERGIZED)  
DOWN (CTR'L + DOWN ENERGIZED)

CONTROL VALVE OPT. "LOW-BUOY" , "A" OR "B" SETTING:

POSITION "A": VALVE IS OPEN,  
AIR FLOW BETWEEN SUPPLY (S) AND  
DELIVERY (D) , LOW-BUOY IS IN FUNCTION.

POSITION "B": VALVE CLOSED,  
AIR DOES'NT FLOW BETWEEN SUPPLY (S) AND  
DELIVERY (D) , LOW-BUOY IS NOT IN FUNCTION.

TUBE COLOR CODING		
LINE TYPE	COLOR	CIRCUIT
---	BLUE	SUSPENSION
---	BLACK	ACCESSORIES
---	YELLOW	PARKING BRAKES

**PREVOST®**

DESCRIPTION:  
X3-45 COACH, WITH INDEPENDENT FRONT SUSPENSION (I.F.S.) WITH  
OPTION FRONT KNEELING, LOW-BUOY & HIGH-BUOY COMBINATION

EFF. W/VEH. : #8-9288...

DATE: 2007/05 REV.: C

PAGE:  
D140330 P4.1

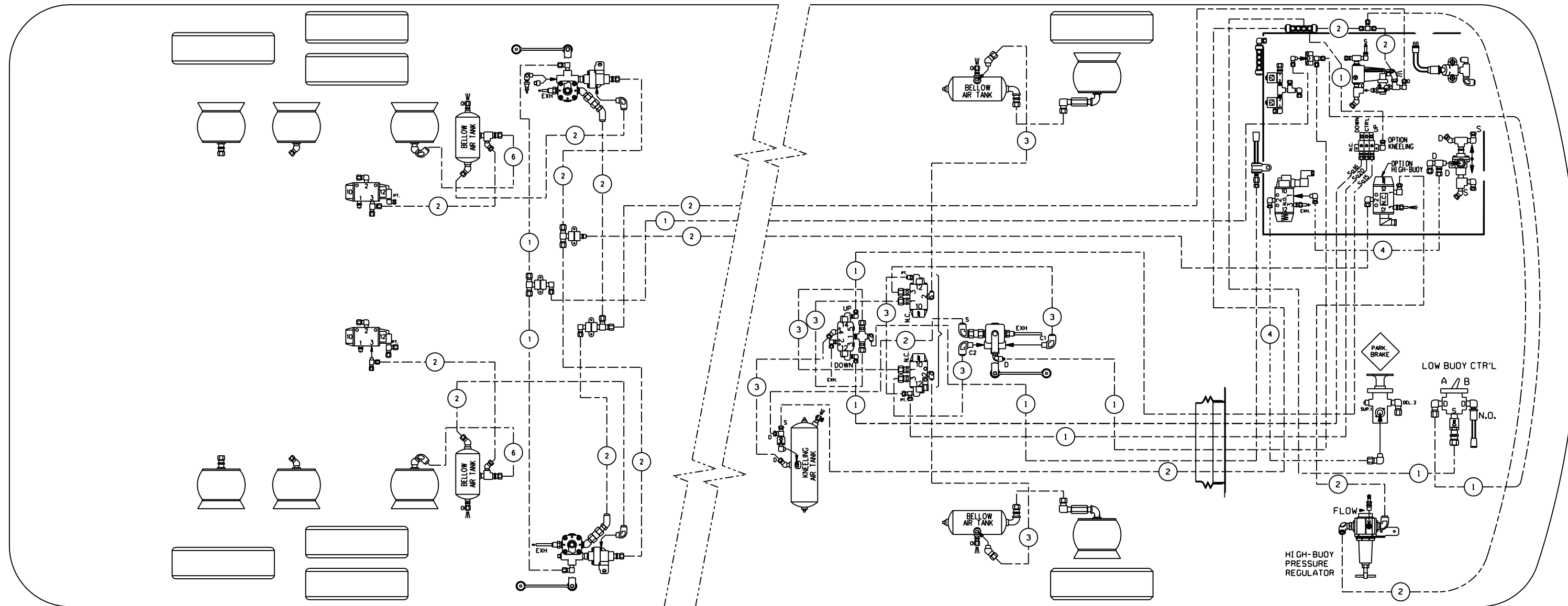

BALLOON	PIPE
*1	1/4" O.D. BLUE
*2	3/8" O.D. BLUE
*3	1/2" O.D. BLUE
*4	3/8" O.D. YELLOW
*5	3/8" O.D. BLACK
*6	3/4" O.D. BLACK

NOTE:

KNEELING SYSTEM = UP (CTR'L + UP ENERGIZED)  
DOWN (CTR'L + DOWN ENERGIZED)

CONTROL VALVE OPT. "LOW-BUOY" , "A" OR "B" SETTING:

POSITION "A": VALVE IS OPEN,  
AIR FLOW BETWEEN SUPPLY (S) AND  
DELIVERY (D) , LOW-BUOY IS IN FUNCTION.

POSITION "B": VALVE CLOSED,  
AIR DOESN'T FLOW BETWEEN SUPPLY (S) AND  
DELIVERY (D) , LOW-BUOY IS NOT IN FUNCTION.

TUBE COLOR CODING		
LINE TYPE	COLOR	CIRCUIT
---	BLUE	SUSPENSION
---	BLACK	ACCESSORIES
---	YELLOW	PARKING BRAKES

**PREVOST®**

DESCRIPTION:

X3-45 COACH, WITH INDEPENDENT FRONT SUSPENSION (I.F.S.) WITH  
OPTION FRONT KNEELING, LOW-BUOY & HIGH-BUOY COMBINATION

EFF. W/VEH. :

#8-9430

DATE:

2008/04

REV.:

D

PAGE:

D140330 P4.1

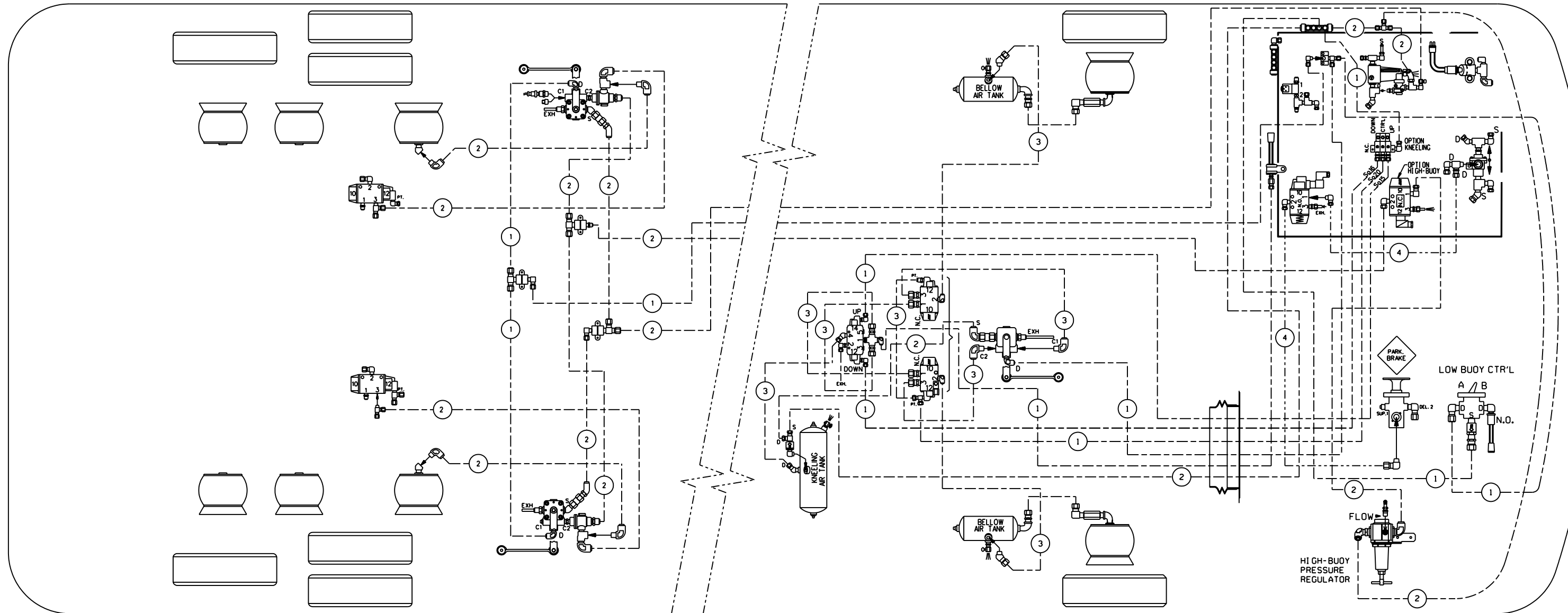

BALLOON	PIPE
*1	1/4" O.D. BLUE
*2	3/8" O.D. BLUE
*3	1/2" O.D. BLUE
*4	3/8" O.D. YELLOW
*5	3/8" O.D. BLACK
*6	3/4" O.D. BLACK

**NOTE:**

KNEELING SYSTEM = UP (CTR'L + UP ENERGIZED)  
DOWN (CTR'L + DOWN ENERGIZED)

CONTROL VALVE OPT. "LOW-BUOY" , "A" OR "B" SETTING:

POSITION "A": VALVE IS OPEN,  
AIR FLOW BETWEEN SUPPLY (S) AND  
DELIVERY (D) , LOW-BUOY IS IN FUNCTION.

POSITION "B": VALVE CLOSED,  
AIR DOES'NT FLOW BETWEEN SUPPLY (S) AND  
DELIVERY (D) , LOW-BUOY IS NOT IN FUNCTION.

TUBE COLOR CODING		
LINE TYPE	COLOR	CIRCUIT
---	BLUE	SUSPENSION
---	BLACK	ACCESSORIES
---	YELLOW	PARKING BRAKES

**PREVOST**

DESCRIPTION:

X3-45 COACH, WITH INDEPENDENT FRONT SUSPENSION (I.F.S.) WITH  
OPTION FRONT KNEELING, LOW-BUOY & HIGH-BUOY COMBINATION

EFF. W/VEH. :

#9-9599...

PAGE:

D140330 P4.1

DATE:

2008/08

REV.:

E

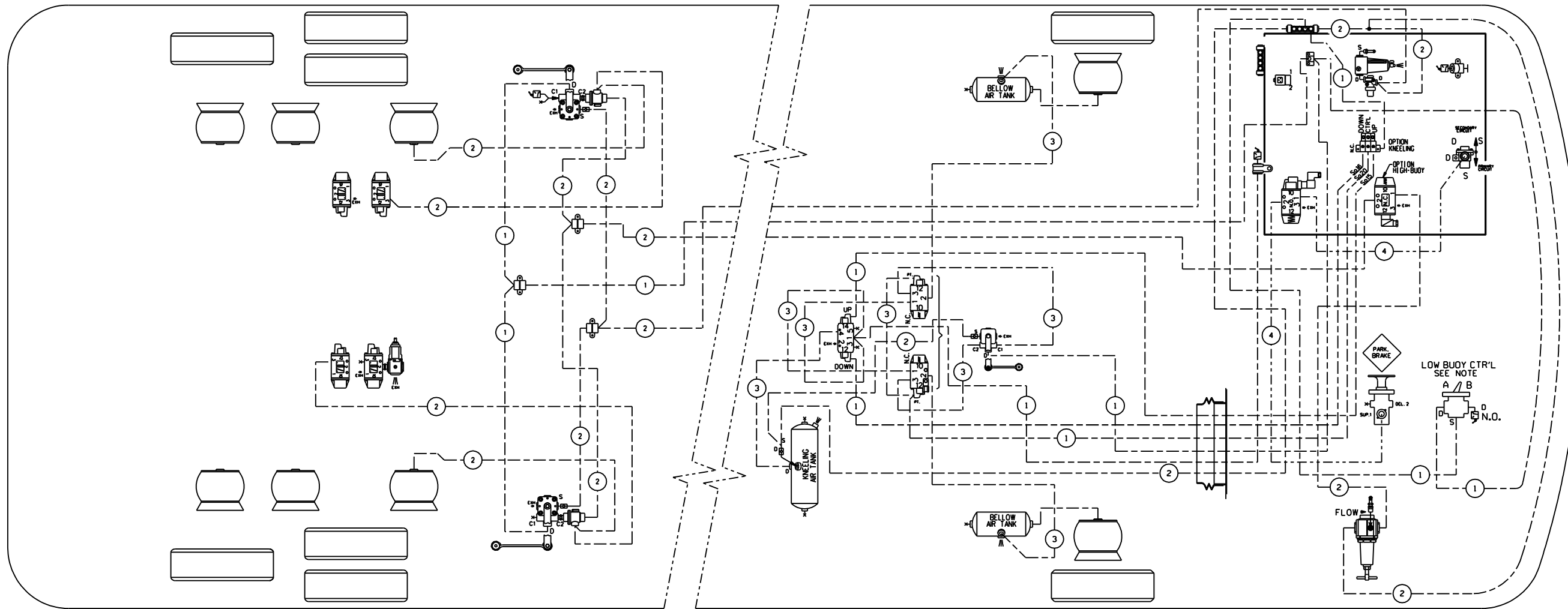

BALLOON	PIPE
*1	1/4" O.D. BLUE
*2	3/8" O.D. BLUE
*3	1/2" O.D. BLUE
*4	3/8" O.D. YELLOW
*5	3/8" O.D. BLACK
*6	3/4" O.D. BLACK

**NOTE:**

KNEELING SYSTEM = UP (CTR'L + UP ENERGIZED)  
DOWN (CTR'L + DOWN ENERGIZED)

CONTROL VALVE OPT. "LOW-BUOY" , "A" OR "B" SETTING:

POSITION "A": VALVE IS OPEN,  
AIR FLOW BETWEEN SUPPLY (S) AND  
DELIVERY (D) , LOW-BUOY IS IN FUNCTION.

POSITION "B": VALVE CLOSED,  
AIR DOES'NT FLOW BETWEEN SUPPLY (S) AND  
DELIVERY (D) , LOW-BUOY IS NOT IN FUNCTION.

TUBE COLOR CODING		
LINE TYPE	COLOR	CIRCUIT
---	BLUE	SUSPENSION
---	BLACK	ACCESSORIES
---	YELLOW	PARKING BRAKES

**PREVOST**®

DESCRIPTION:  
X3-45 COACH, WITH INDEPENDENT FRONT SUSPENSION (I.F.S.) WITH  
OPTION FRONT KNEELING, LOW-BUOY & HIGH-BUOY COMBINATION

EFF. W/VEH. : #A-9953  
DATE: 2010/04 REV.: F

PAGE:  
D140330 P4.1

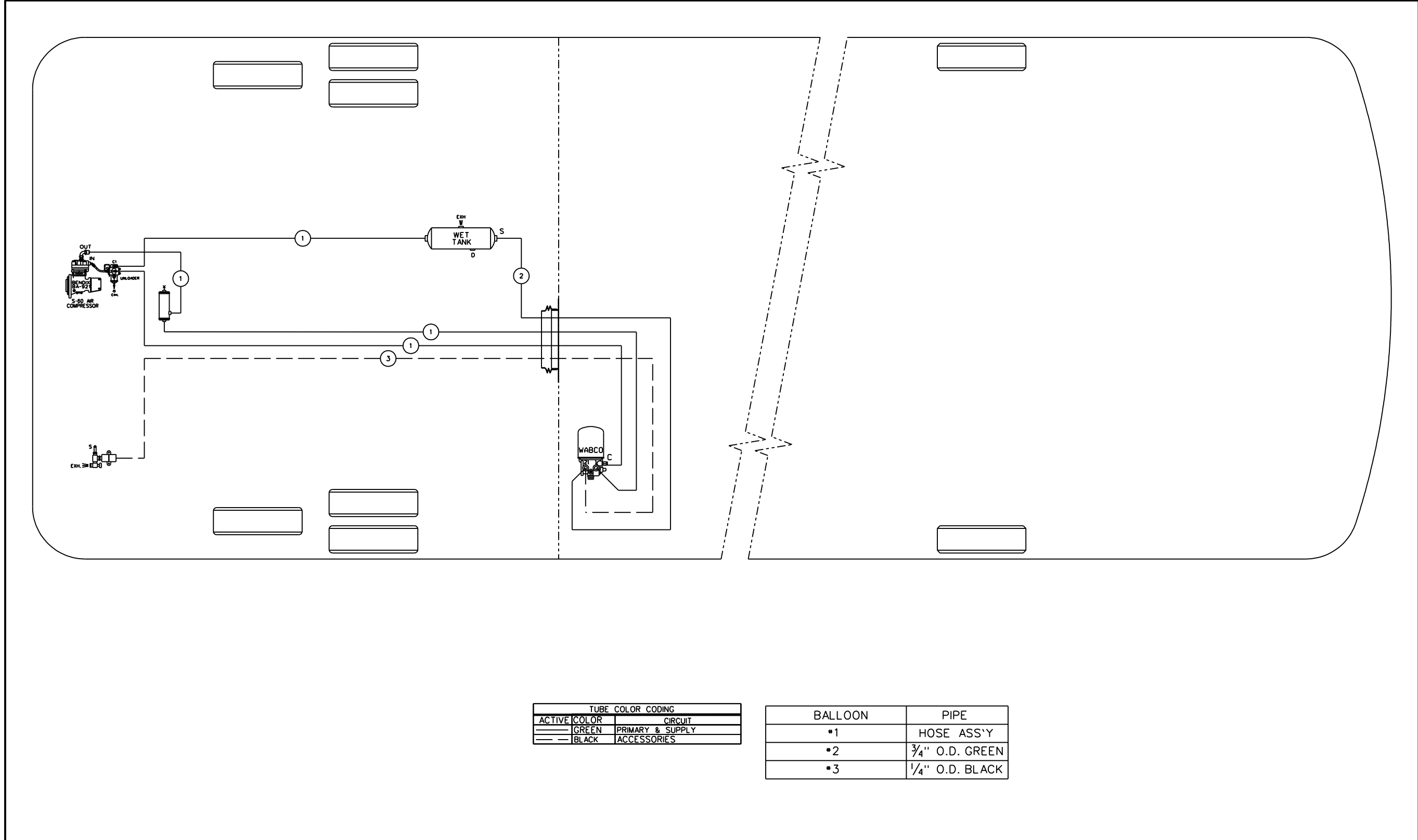

TUBE COLOR CODING		
ACTIVE	COLOR	CIRCUIT
—	GREEN	PRIMARY & SUPPLY
—	BLACK	ACCESSORIES

BALLOON	PIPE
•1	HOSE ASS'Y
•2	3/4" O.D. GREEN
•3	1/4" O.D. BLACK

**PREVOST**®

DESCRIPTION:  
 X3-45 COACH, WITH INDEPENDENT FRONT SUSPENSION (I.F.S.)  
 WITH OPTION WABCO AIR DRYER

EFF. W/ VEH : #A-9953...  
 DATE: 2010/05 REV.: B

PAGE:  
 D140330 SP4.1



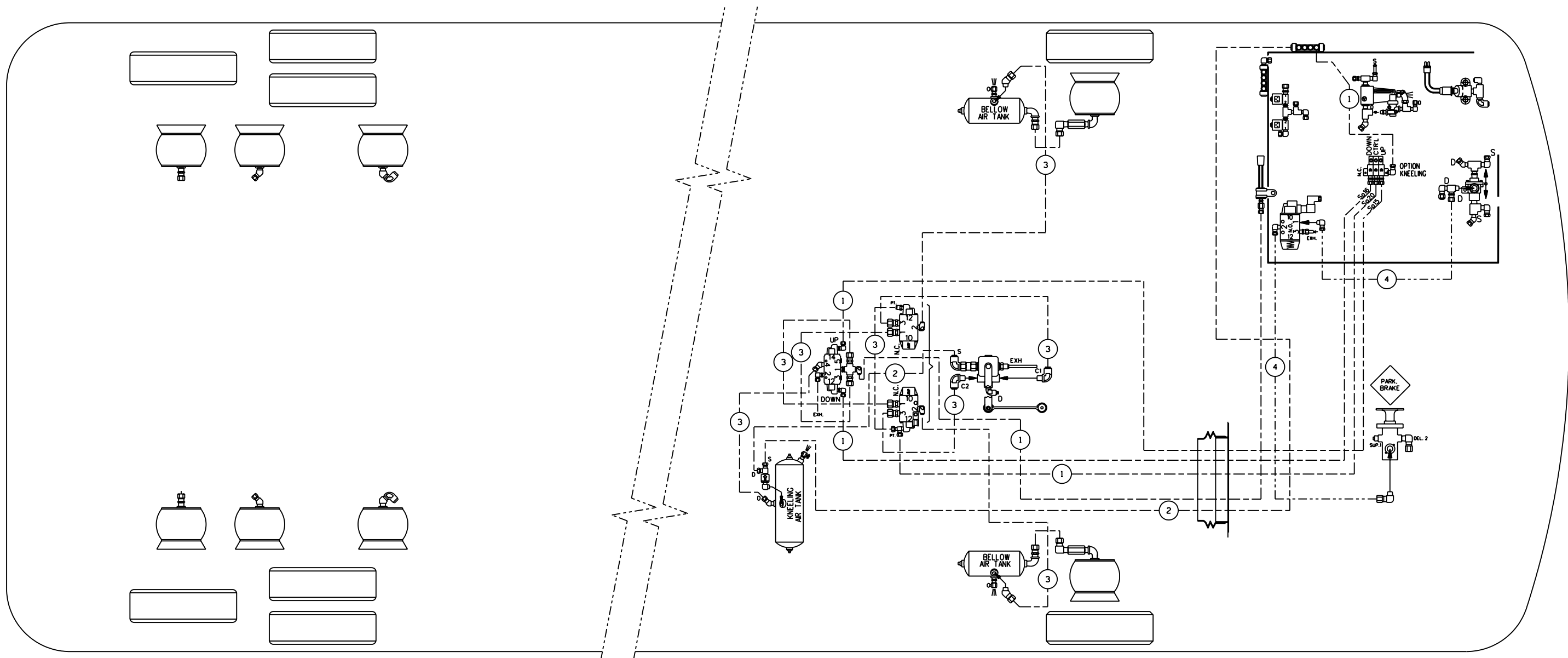

KNEELING SYSTEM = UP (CTR'L + UP ENERGIZED)  
 DOWN (CTR'L + DOWN ENERGIZED)

BALLOON	PIPE
*1	1/4" O.D. BLUE
*2	3/8" O.D. BLUE
*3	1/2" O.D. BLUE
*4	3/8" O.D. YELLOW

TUBE COLOR CODING		
LINE TYPE	COLOR	CIRCUIT
---	BLUE	SUSPENSION
---	YELLOW	PARKING BRAKES

**PREVOST**®

DESCRIPTION:

X3-45 COACH, WITH INDEPENDENT FRONT SUSPENSION (I.F.S.)  
 WITH OPTION FRONT KNEELING

EFF. W/ VEH :

7-8933...

PAGE:

D140330 P5.1

DATE:

2006/03

REV.:

A

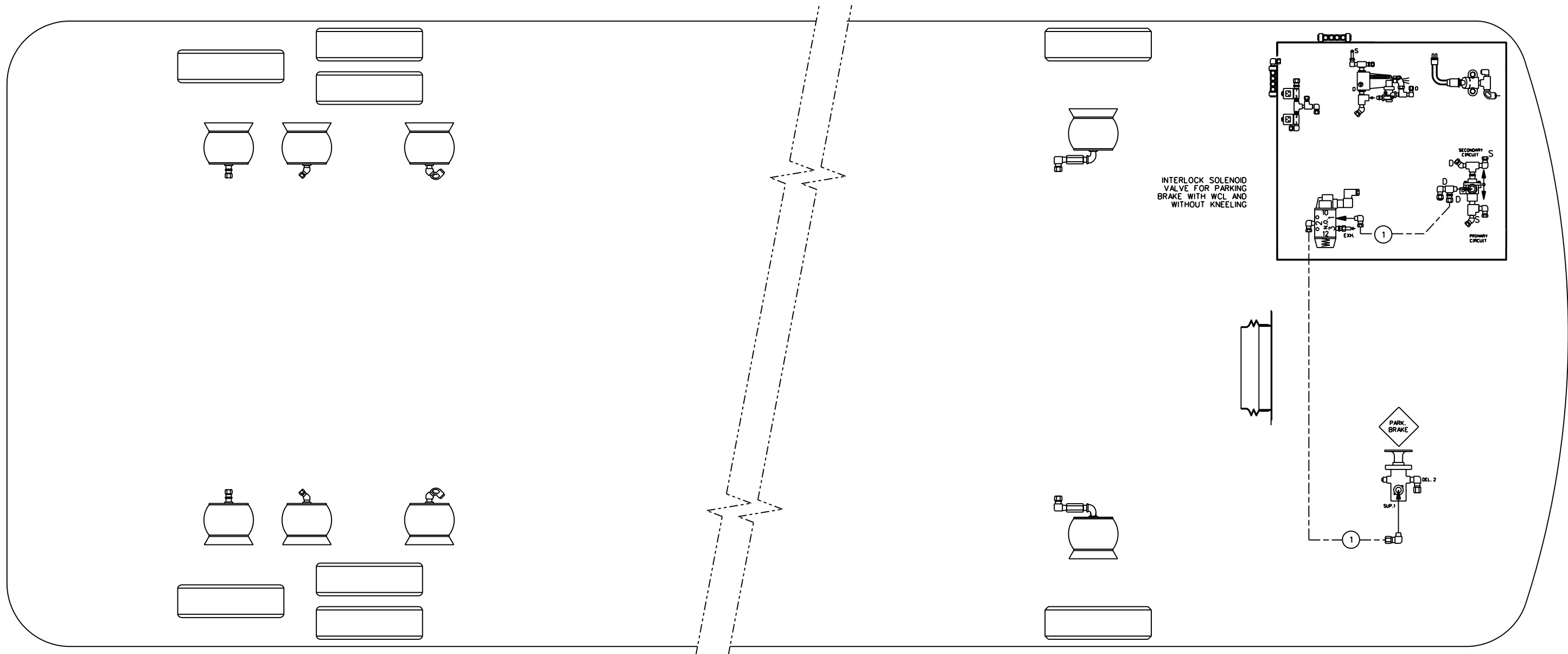

TUBE COLOR CODING	
ACTIVE COLOR	CIRCUIT
---	YELLOW PARKING BRAKE

BALLOON	PIPE
*1	3/8" O.D. YELLOW

**PREVOST**®

DESCRIPTION:  
 X3-45 COACH, WITH INDEPENDENT FRONT SUSPENSION (I.F.S.)  
 WITH OPTION PARKING BRAKE WITH WHEELCHAIR LIFT AND WITHOUT  
 KNEELING

EFF. W/ VEH :  
 TO FOLLOW  
 DATE: 2006/02  
 REV.: A

PAGE:  
 D140330 P6.1

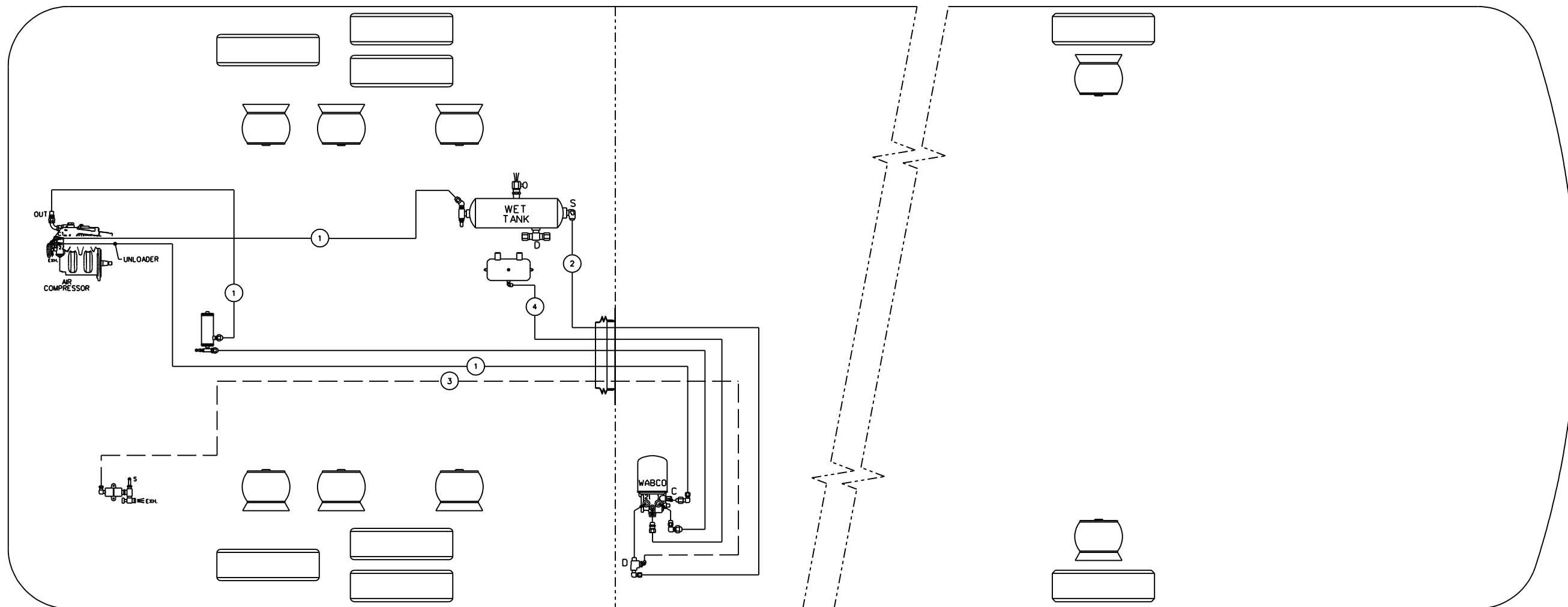

TUBE COLOR CODING	
ACTIVE COLOR	CIRCUIT
— GREEN	PRIMARY & SUPPLY
— BLACK	ACCESSORIES

BALLOON	PIPE
•1	HOSE ASS'Y
•2	3/4" O.D. GREEN
•3	1/4" O.D. BLACK
•4	3/8" O.D. GREY

**PREVOST**®

DESCRIPTION:

X3-45 COACH, MD13 VOLVO ENGINE WITH INDEPENDENT FRONT SUSPENSION (I.F.S.) WITH OPTION WABCO AIR DRYER

EFF. W/ VEH : #A-9953...

PAGE:

DATE: 2010/05

REV.: A

D140330 SP6.1

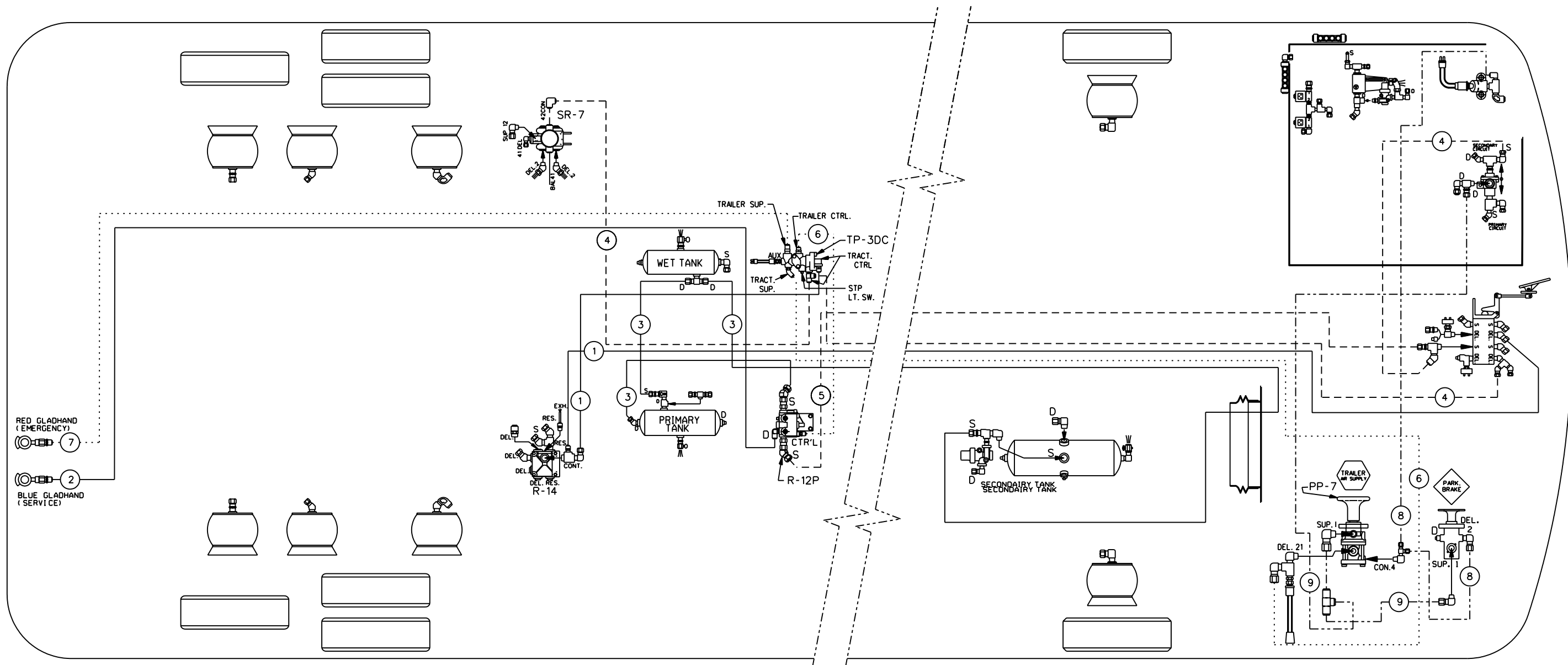

RED GLADHAND  
(EMERGENCY) 7

BLUE GLADHAND  
(SERVICE) 2

TUBE COLOR CODING		
ACTIVE	COLOR	CIRCUIT
---	RED	SECONDARY
---	GREEN	PRIMARY & SUPPLY
---	YELLOW	PARKING BRAKE
---	BROWN	TRAILER

BALLOON	PIPE
#1	3/8" O.D. GREEN
#2	1/2" O.D. GREEN
#3	5/8" O.D. GREEN
#4	3/8" O.D. RED
#5	5/8" O.D. RED
#6	3/8" O.D. BROWN
#7	1/2" O.D. BROWN
#8	1/4" O.D. YELLOW
#9	3/8" O.D. YELLOW

**PREVOST**

DESCRIPTION:  
X3-45 COACH, WITH INDEPENDENT FRONT SUSPENSION (I.F.S.)  
WITH OPTION TRAILER HITCH

EFF. W/ VEH : TO FOLLOW  
DATE: 2006/03 REV.: A

PAGE:  
D140330 P7.1

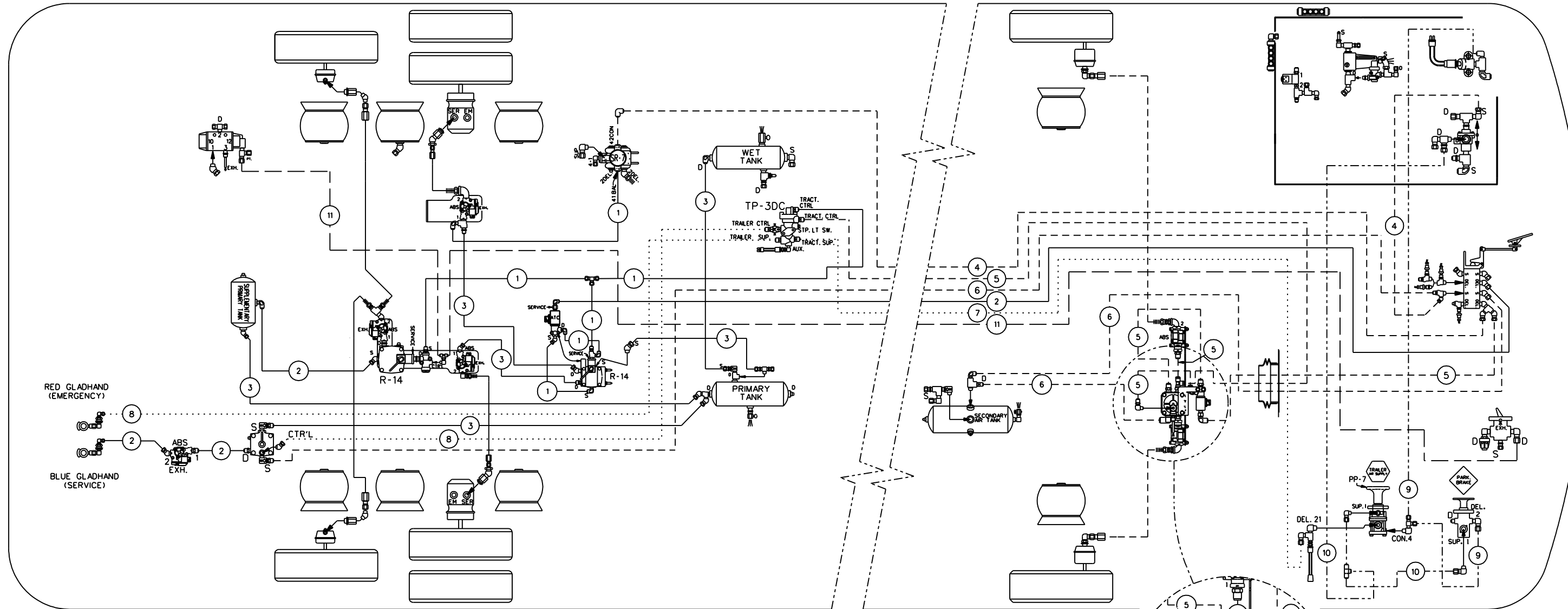

RED GLADHAND  
(EMERGENCY)

BLUE GLADHAND  
(SERVICE)

BALLOON	PIPE
•1	3/8" O.D. GREEN
•2	1/2" O.D. GREEN
•3	5/8" O.D. GREEN
•4	3/8" O.D. RED
•5	1/2" O.D. RED
•6	5/8" O.D. RED
•7	3/8" O.D. BROWN
•8	1/2" O.D. BROWN
•9	1/4" O.D. YELLOW
•10	3/8" O.D. YELLOW
•11	1/4" O.D. BLACK
•12	5/8" O.D. BLACK

TUBE COLOR CODING		
ACTIVE	COLOR	CIRCUIT
---	RED	SECONDARY
---	GREEN	PRIMARY & SUPPLY
---	YELLOW	PARKING BRAKE
---	BROWN	TRAILER
---	BLACK	ACCESSORIES

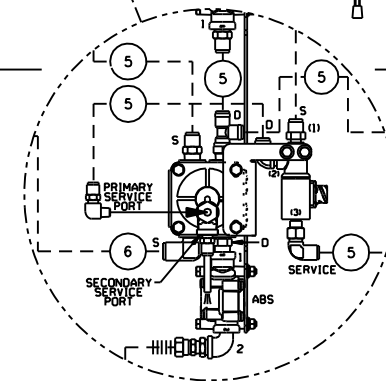

**PREVOST**®

DESCRIPTION:  
X3-45 COACH, WITH INDEPENDENT FRONT SUSPENSION (I.F.S.)  
WITH OPTION TRAILER HITCH AIR BRAKE  
WITH ESP SYSTEM

EFF. W/VEH : #8-9288...

DATE: 2008/07

REV.: D

PAGE:

D140330 P7.1

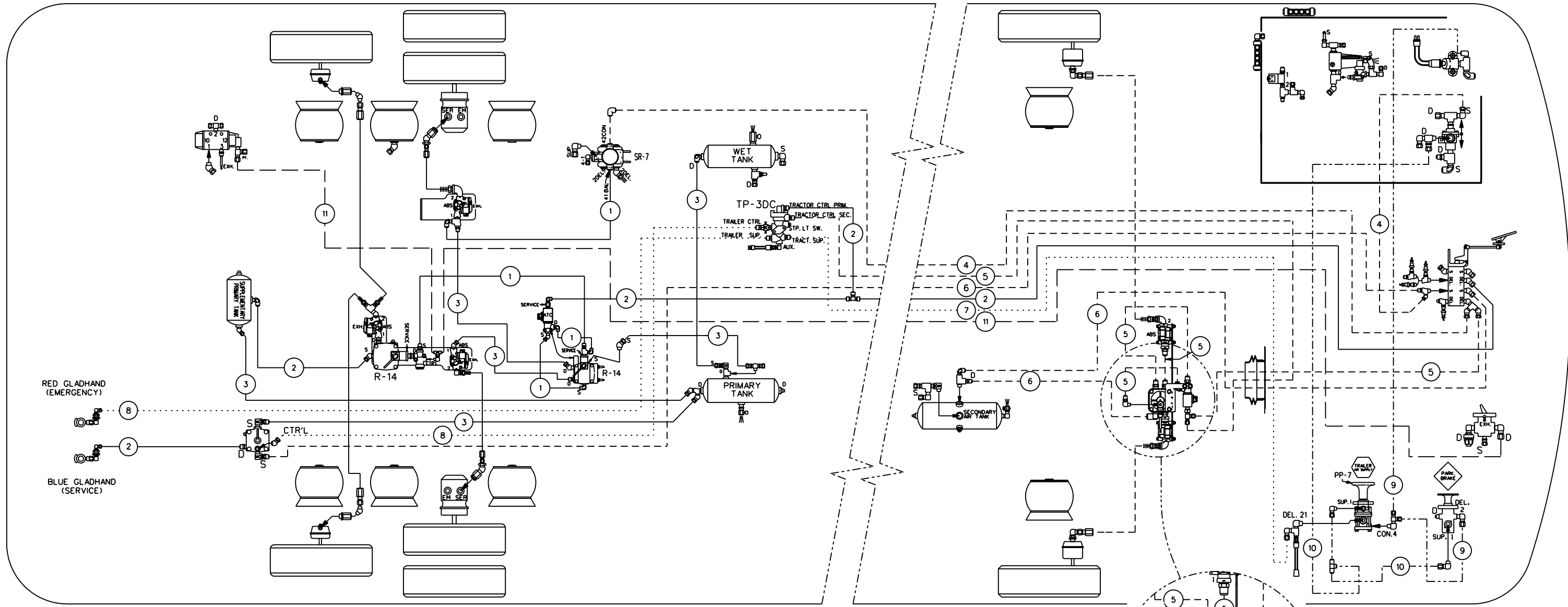

BALLOON	PIPE
•1	3/8" O.D. GREEN
•2	1/2" O.D. GREEN
•3	5/8" O.D. GREEN
•4	3/8" O.D. RED
•5	1/2" O.D. RED
•6	5/8" O.D. RED
•7	3/8" O.D. BROWN
•8	1/2" O.D. BROWN
•9	1/4" O.D. YELLOW
•10	3/8" O.D. YELLOW
•11	1/4" O.D. BLACK
•12	5/8" O.D. BLACK

TUBE COLOR CODING	
ACTIVE	CIRCUIT
---	RED SECONDARY
---	GREEN PRIMARY & SUPPLY
---	YELLOW PARKING BRAKE
---	BROWN TRAILER
---	BLACK ACCESSORIES

**PREVOST**®

DESCRIPTION:  
 X3-45 COACH, WITH INDEPENDENT FRONT SUSPENSION (I.F.S.)  
 WITH OPTION TRAILER HITCH AIR BRAKE  
 WITH ESP SYSTEM

EFF. W/VEH : #9-9674...  
 DATE: 2008/12  
 REV.: E

PAGE:  
 D140330 P7.1

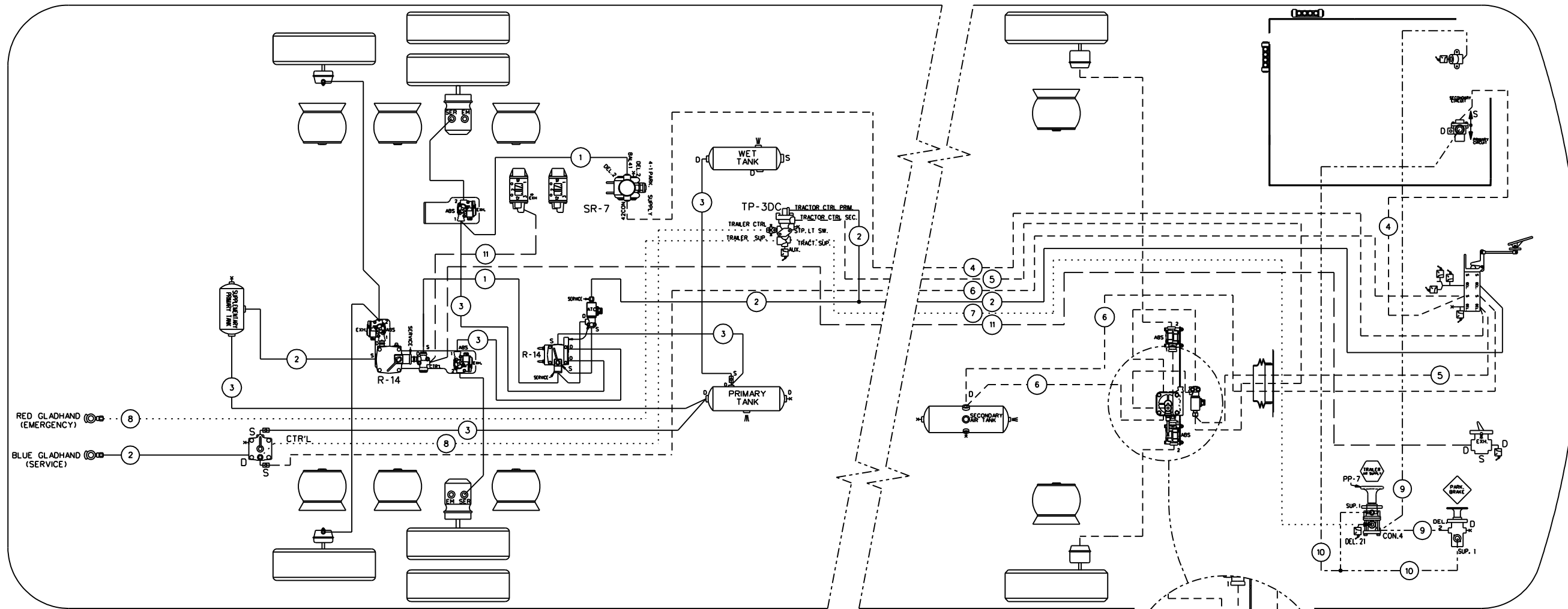

BALLOON	PIPE
*1	3/8" O.D. GREEN
*2	1/2" O.D. GREEN
*3	5/8" O.D. GREEN
*4	3/8" O.D. RED
*5	1/2" O.D. RED
*6	5/8" O.D. RED
*7	3/8" O.D. BROWN
*8	1/2" O.D. BROWN
*9	1/4" O.D. YELLOW
*10	3/8" O.D. YELLOW
*11	1/4" O.D. BLACK
*12	5/8" O.D. BLACK

TUBE COLOR CODING	
ACTIVE COLOR	CIRCUIT
---	RED SECONDARY
---	GREEN PRIMARY & SUPPLY
---	YELLOW PARKING BRAKE
---	BROWN TRAILER
---	BLACK ACCESSORIES

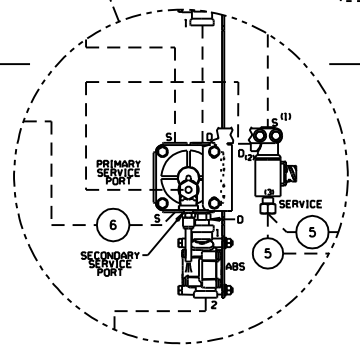

**PREVOST**

DESCRIPTION:  
 X3-45 COACH, WITH INDEPENDENT FRONT SUSPENSION (I.F.S.)  
 WITH OPTION TRAILER HITCH AIR BRAKE  
 WITH ESP SYSTEM

EFF. W/VEH : #A-9953  
 DATE: 2010/04 REV.: F

PAGE:  
 D140330 P7.1

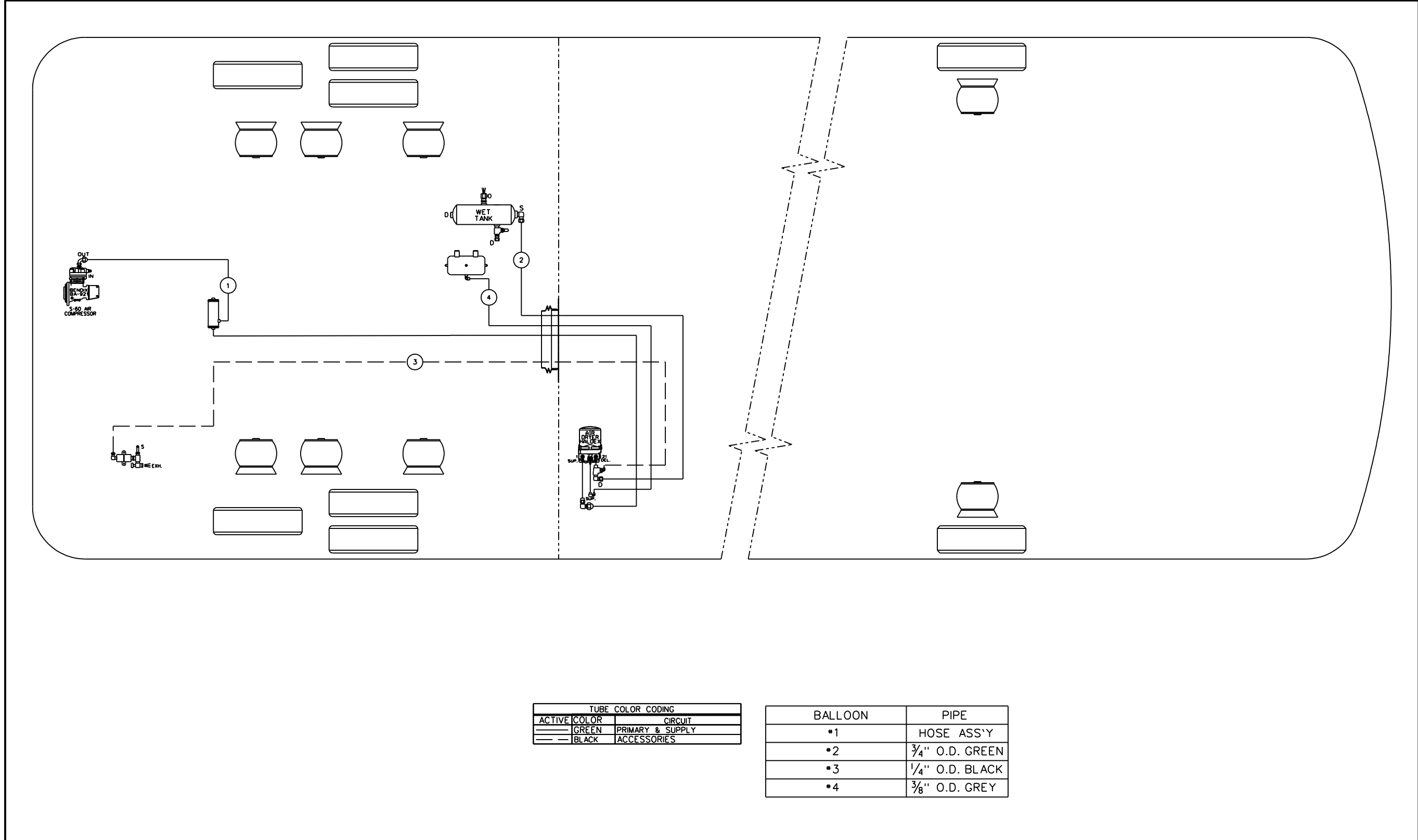

TUBE COLOR CODING		
ACTIVE COLOR		CIRCUIT
— GREEN		PRIMARY & SUPPLY
— BLACK		ACCESSORIES

BALLOON	PIPE
•1	HOSE ASS'Y
•2	3/4" O.D. GREEN
•3	1/4" O.D. BLACK
•4	3/8" O.D. GREY



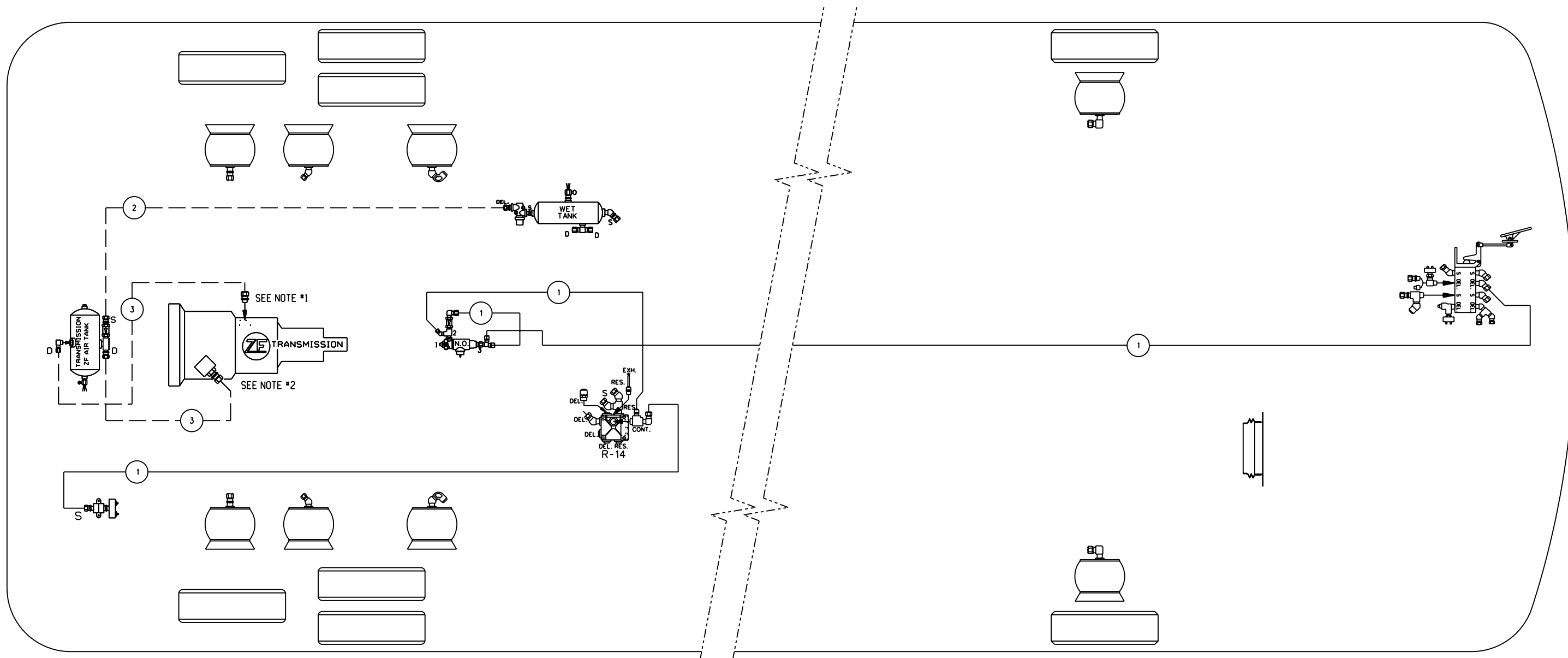

- NOTE #1: COMPRESSED AIR LINE FOR CLUTCH ACTUATOR  
 #2: COMPRESSED AIR LINE FOR TRANSMISSION ACTUATOR  
 #3: BASED ON #D140300 P.1

TUBE COLOR CODING	
ACTIVE COLOR	CIRCUIT
— GREEN	PRIMARY & SUPPLY
— BLACK	ACCESSORIES

BALLOON	PIPE
*1	3/8" O.D. GREEN
*2	3/8" O.D. BLACK
*3	5/8" O.D. BLACK

**PREVOST®**

DESCRIPTION:

X3-45 COACH, WITH INDEPENDENT FRONT SUSPENSION (I.F.S.)  
 WITH OPTION TRANSMISSION ZF

EFF. W/ VEH :

7-8933...

PAGE:

D140330 P8.1

DATE:

2006/03

REV.:

A

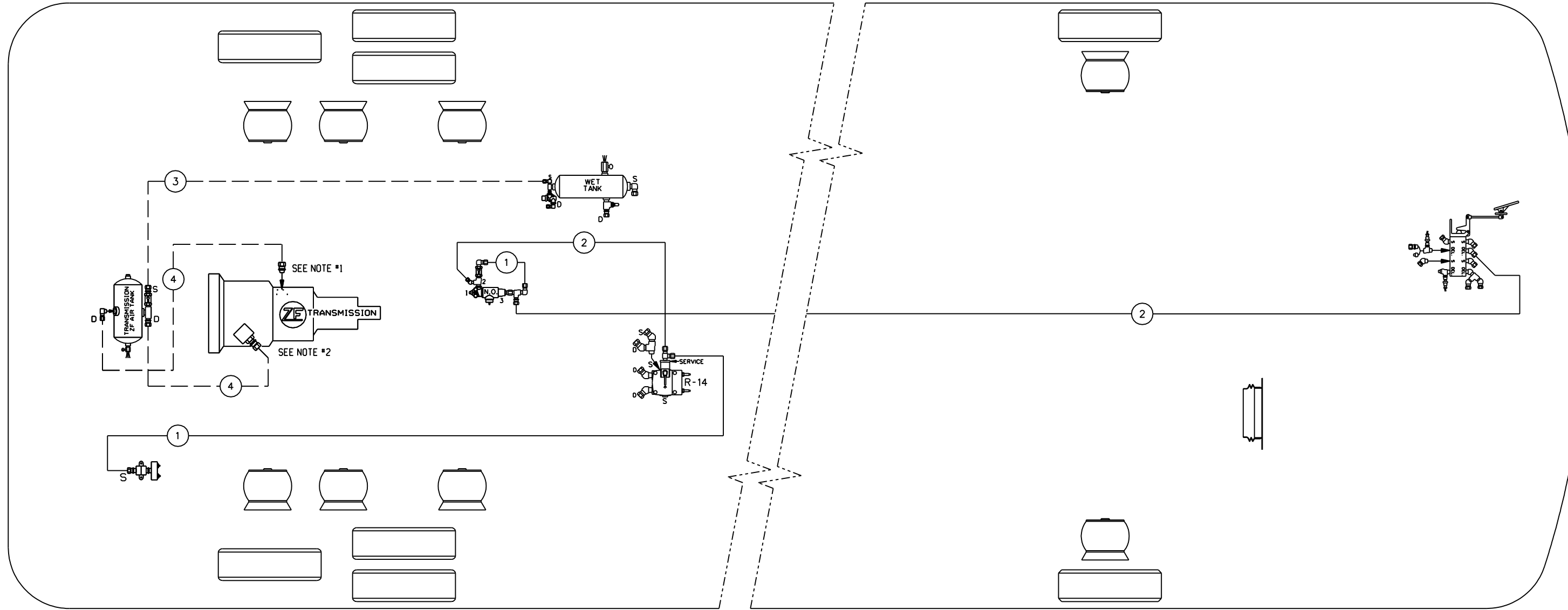

NOTE #1: COMPRESSED AIR LINE FOR CLUTCH ACTUATOR  
 #2: COMPRESSED AIR LINE FOR TRANSMISSION ACTUATOR  
 #3: BASED ON #D140300 P.1

TUBE COLOR CODING	
ACTIVE COLOR	CIRCUIT
GREEN	PRIMARY & SUPPLY
BLACK	ACCESSORIES

BALLOON	PIPE
#1	3/8" O.D. GREEN
#2	1/2" O.D. GREEN
#3	3/8" O.D. BLACK
#4	5/8" O.D. BLACK

**PREVOST®**

DESCRIPTION:  
 X3-45 COACH, WITH INDEPENDENT FRONT SUSPENSION (I.F.S.)  
 WITH OPTION TRANSMISSION ZF

EFF. W/ VEH : #8-9288...  
 DATE: 2007/05 REV.: B

PAGE:  
 D140330 P8.1

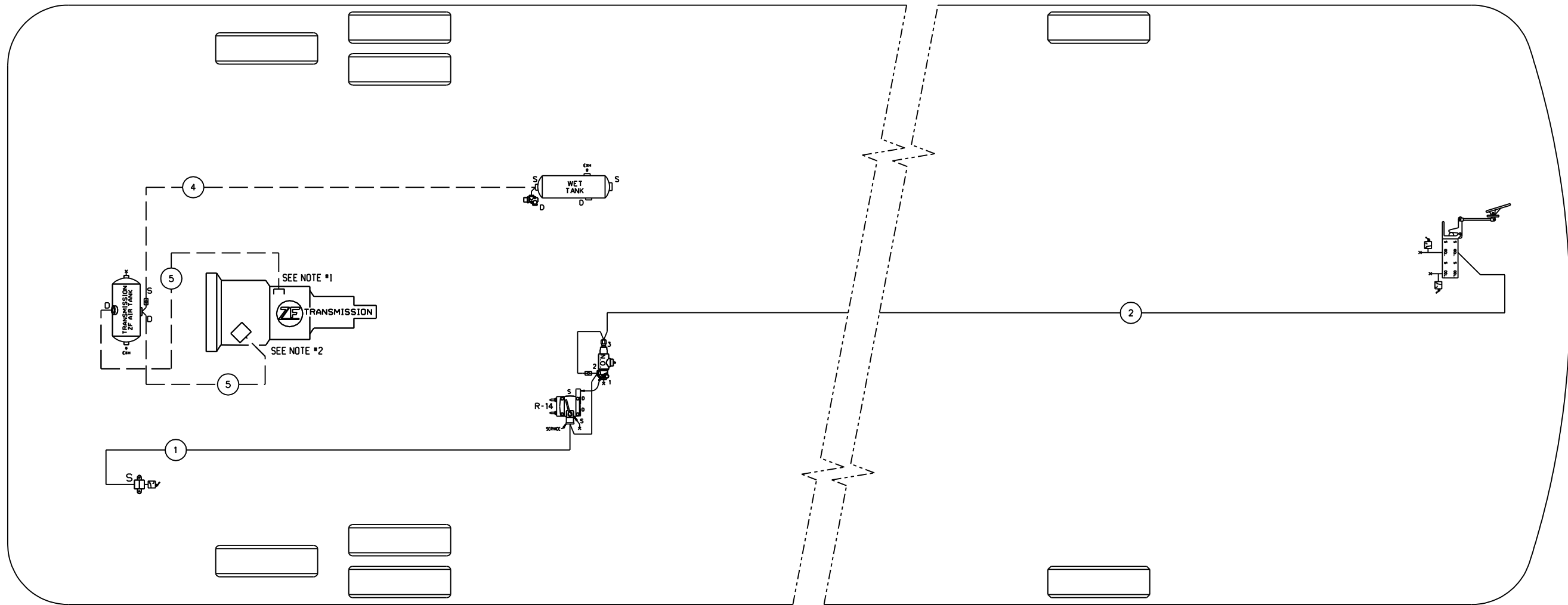

NOTE #1: COMPRESSED AIR LINE FOR CLUTCH ACTUATOR  
 #2: COMPRESSED AIR LINE FOR TRANSMISSION ACTUATOR  
 #3: BASED ON #D140300 P.1

TUBE COLOR CODING	
ACTIVE COLOR	CIRCUIT
— GREEN	PRIMARY & SUPPLY
— BLACK	ACCESSORIES

BALLOON	PIPE
#1	3/8" O.D. GREEN
#2	1/2" O.D. GREEN
#3	3/4" O.D. GREEN
#4	3/8" O.D. BLACK
#5	5/8" O.D. BLACK

**PREVOST**

DESCRIPTION:  
 X3-45 COACH, WITH INDEPENDENT FRONT SUSPENSION (I.F.S.)  
 WITH OPTION TRANSMISSION ZF

EFF. W/ VEH : #A-9953  
 DATE: 2010/04  
 REV.: C

PAGE:  
 D140330 P8.1

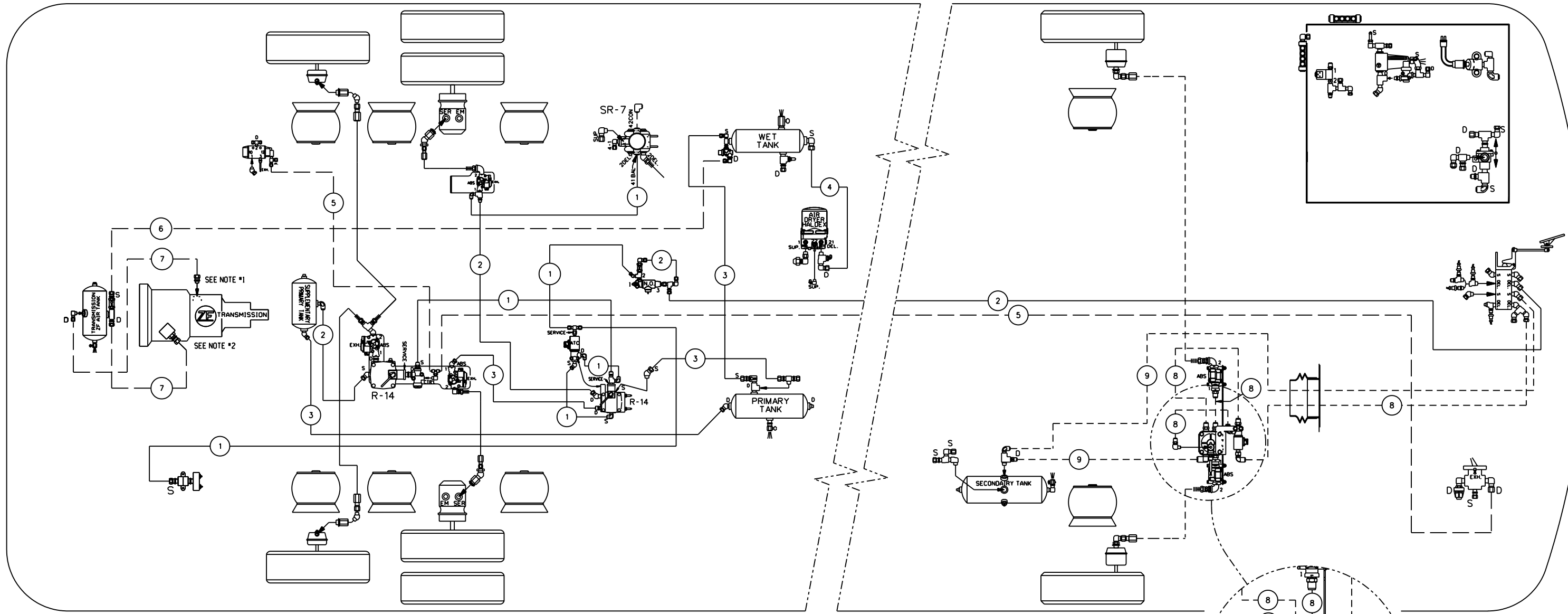

NOTE #1: COMPRESSED AIR LINE FOR CLUTCH ACTUATOR  
 #2: COMPRESSED AIR LINE FOR TRANSMISSION ACTUATOR

BALLOON	PIPE
#1	3/8" O.D. GREEN
#2	1/2" O.D. GREEN
#3	5/8" O.D. GREEN
#4	3/4" O.D. GREEN
#5	1/4" O.D. BLACK
#6	3/8" O.D. BLACK
#7	1/2" O.D. BLACK
#8	1/2" O.D. RED
#9	5/8" O.D. RED

TUBE COLOR CODING	
ACTIVE COLOR	CIRCUIT
— (Green)	PRIMARY & SUPPLY
— (Black)	ACCESSORIES
--- (Red)	SECONDARY

# PREVOST®

DESCRIPTION:  
 X3-45 COACH, WITH INDEPENDENT FRONT SUSPENSION (I.F.S.)  
 WITH TRANSMISSION ZF & ESP BRAKE SYSTEM OPTION

EFF. W/ VEH : #8-9341...  
 DATE: 2008/03  
 REV.: B

PAGE:  
 D140330 P9.1

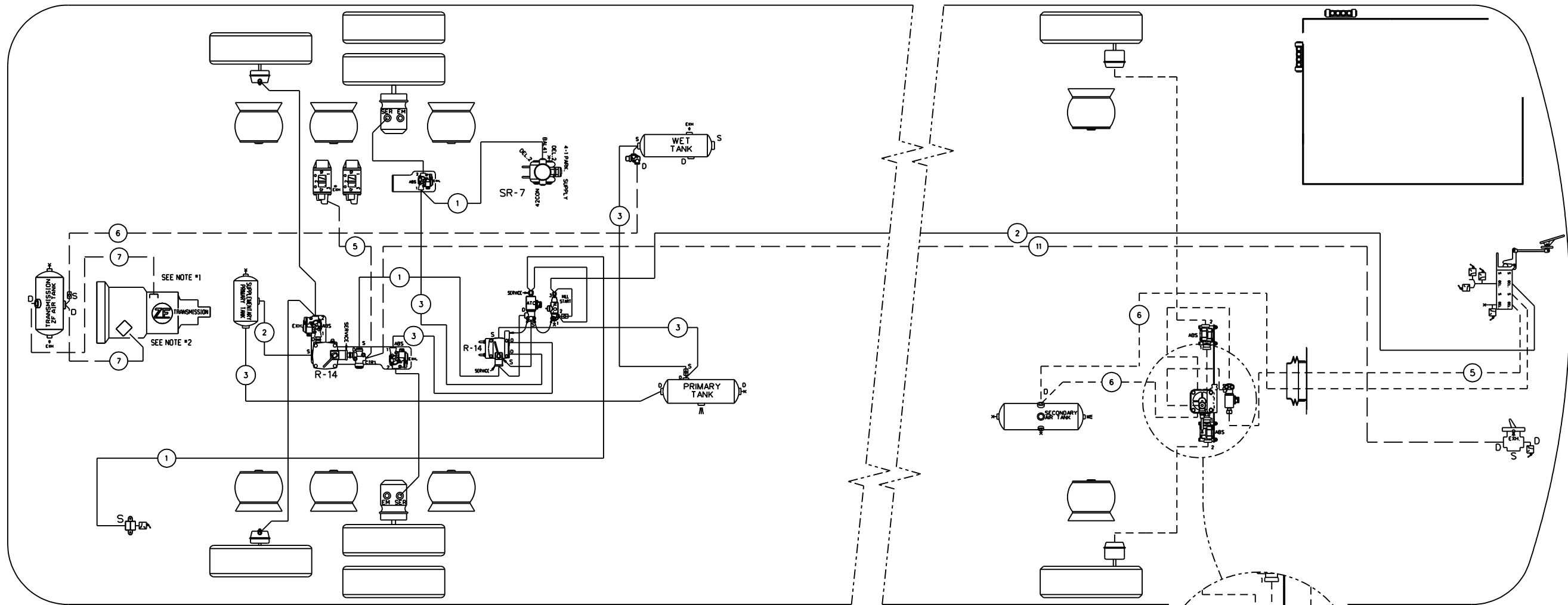

NOTE #1: COMPRESSED AIR LINE FOR CLUTCH ACTUATOR  
 #2: COMPRESSED AIR LINE FOR TRANSMISSION ACTUATOR

BALLOON	PIPE
#1	3/8" O.D. GREEN
#2	1/2" O.D. GREEN
#3	5/8" O.D. GREEN
#4	3/4" O.D. GREEN
#5	1/4" O.D. BLACK
#6	3/8" O.D. BLACK
#7	1/2" O.D. BLACK
#8	1/2" O.D. RED
#9	5/8" O.D. RED

TUBE COLOR CODING		
ACTIVE	COLOR	CIRCUIT
—	GREEN	PRIMARY & SUPPLY
—	BLACK	ACCESSORIES
---	RED	SECONDARY

**PREVOST**

DESCRIPTION:  
 X3-45 COACH, WITH INDEPENDENT FRONT SUSPENSION (I.F.S.)  
 WITH TRANSMISSION ZF & ESP BRAKE SYSTEM OPTION

EFF. W/ VEH : #A-9953  
 DATE: 2010/04 REV.: C

PAGE:  
 D140330 P9.1

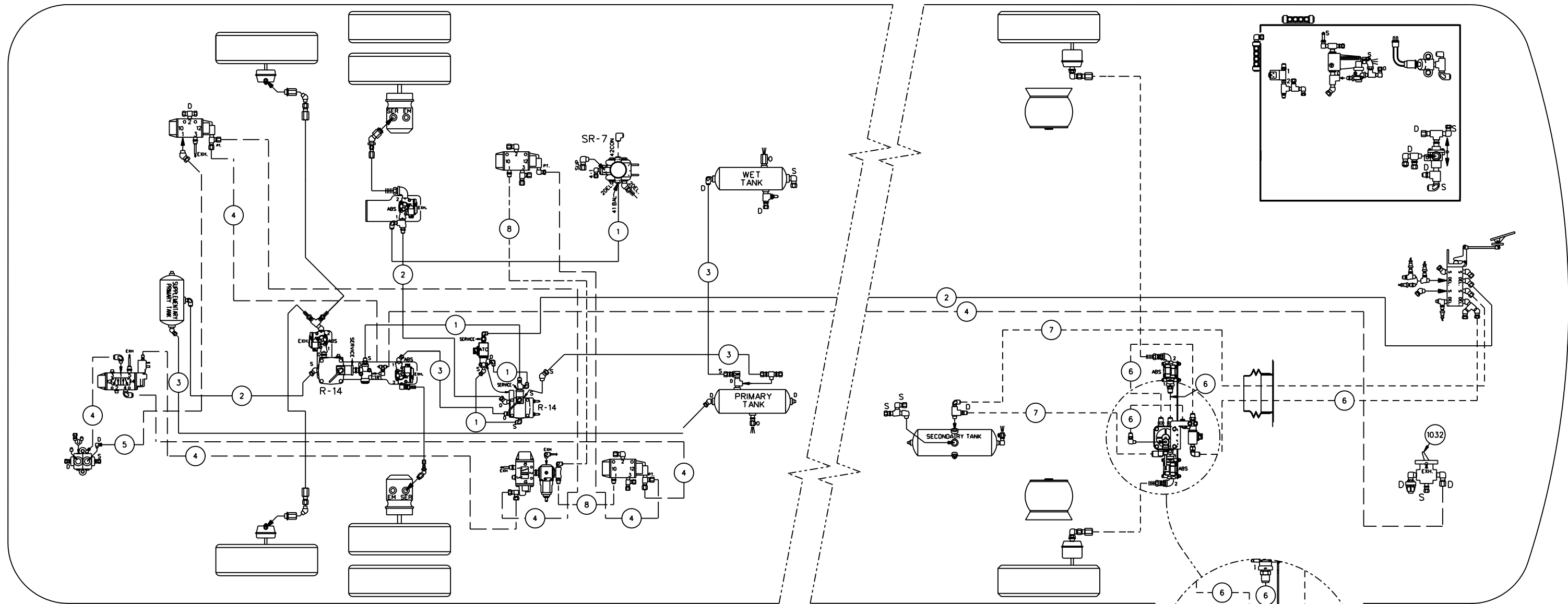

BALLOON	PIPE
*1	3/8" O.D. GREEN
*2	1/2" O.D. GREEN
*3	5/8" O.D. GREEN
*4	1/4" O.D. BLACK
*5	3/8" O.D. BLACK
*6	1/2" O.D. RED
*7	5/8" O.D. RED
*8	3/8" O.D. BLUE

TUBE COLOR CODING		
ACTIVE	COLOR	CIRCUIT
—	GREEN	PRIMARY & SUPPLY
—	BLACK	ACCESSORIES
- - - -	RED	SECONDARY

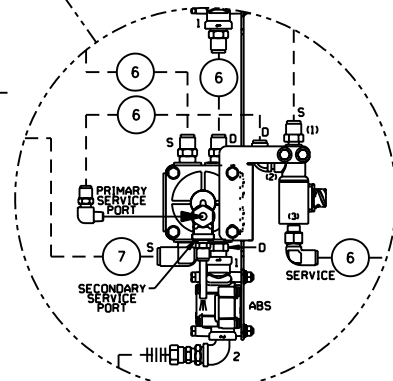

**PREVOST**®

DESCRIPTION:

X3-45 COACH, WITH INDEPENDENT FRONT SUSPENSION (I.F.S.)  
WITH ESP BRAKE SYSTEM OPTION

EFF. W/ VEH : #8-9288

PAGE:

DATE: 2008/03

REV.: B

D140330 P10.1

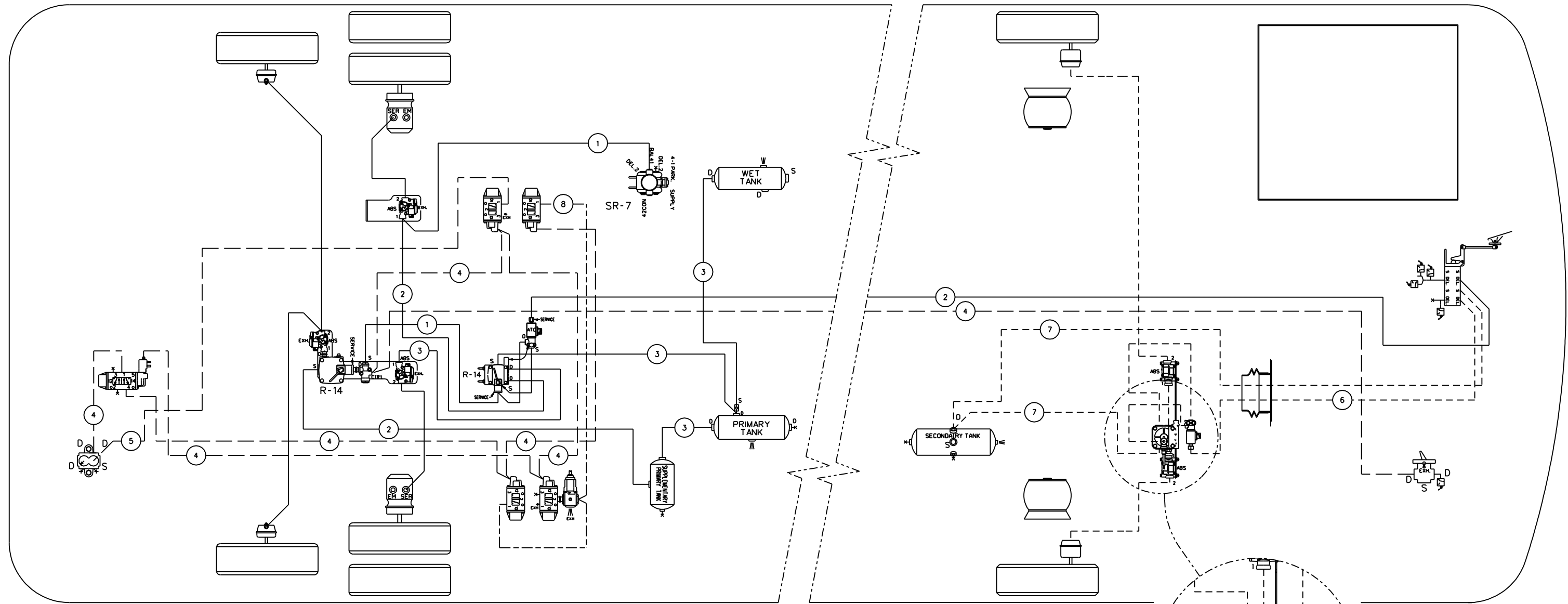

BALLOON	PIPE
*1	3/8" O.D. GREEN
*2	1/2" O.D. GREEN
*3	5/8" O.D. GREEN
*4	1/4" O.D. BLACK
*5	3/8" O.D. BLACK
*6	1/2" O.D. RED
*7	5/8" O.D. RED
*8	3/8" O.D. BLUE

TUBE COLOR CODING		
ACTIVE	COLOR	CIRCUIT
—	GREEN	PRIMARY & SUPPLY
---	BLACK	ACCESSORIES
- - -	RED	SECONDARY

**PREVOST**

DESCRIPTION:  
X3-45 COACH, WITH INDEPENDENT FRONT SUSPENSION (I.F.S.)  
WITH ABS 6, ADVANCED OPTION

EFF. W/ VEH : #A-9953  
DATE: 2010/04 REV.: D

PAGE:  
D140330 P10.1

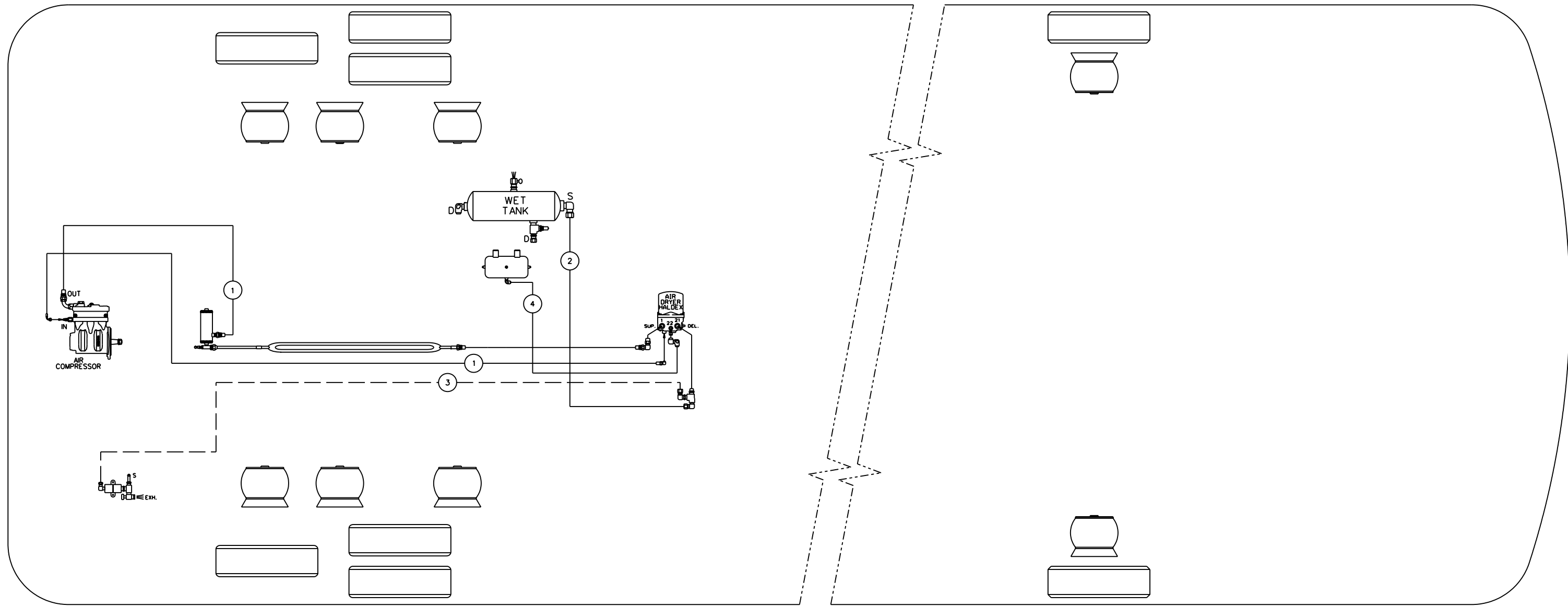

TUBE COLOR CODING	
ACTIVE COLOR	CIRCUIT
GREEN	PRIMARY & SUPPLY
BLACK	ACCESSORIES

BALLOON	PIPE
*1	HOSE ASS'Y
*2	3/4" O.D. GREEN
*3	1/4" O.D. BLACK
*4	3/8" O.D. GREY

**PREVOST**

DESCRIPTION:  
 X3-45 COACH, MD13 VOLVO ENGINE WITH INDEPENDENT FRONT SUSPENSION (I.F.S.) WITH OPTION HALDEX AIR DRYER

EFF. W/ VEH : #8-9514...  
 DATE: 2008/01  
 REV.: A

PAGE:  
 D140330 P11.1



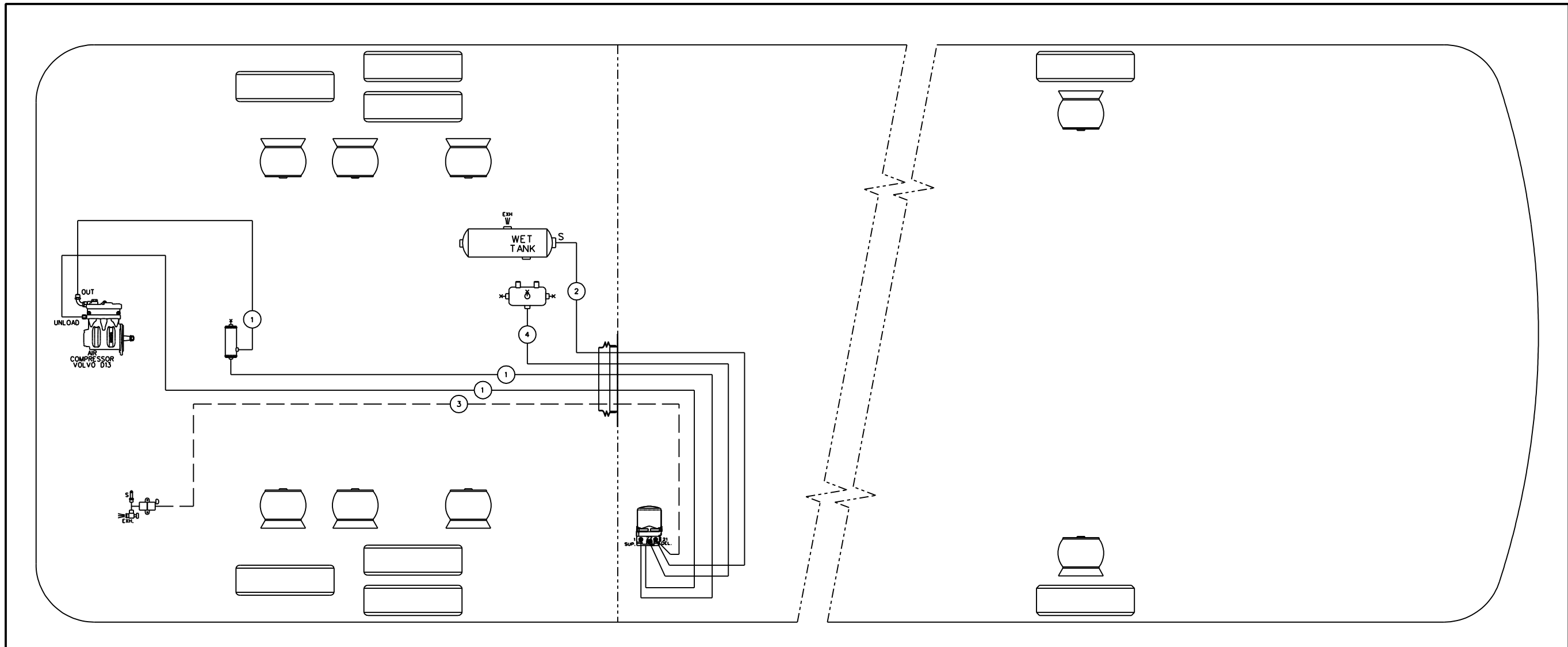

TUBE COLOR CODING		
ACTIVE	COLOR	CIRCUIT
—	GREEN	PRIMARY & SUPPLY
—	BLACK	ACCESSORIES

BALLOON	PIPE
•1	HOSE ASS'Y
•2	3/4" O.D. GREEN
•3	1/4" O.D. BLACK
•4	3/8" O.D. GREY

**PREVOST®**

DESCRIPTION:

X3-45 COACH, MD13 VOLVO ENGINE WITH INDEPENDENT FRONT SUSPENSION (I.F.S.) WITH OPTION HALDEX AIR DRYER

EFF. W/ VEH :

#A-9953

PAGE:

D140330 P11.1

DATE: 2010/04

REV.: B

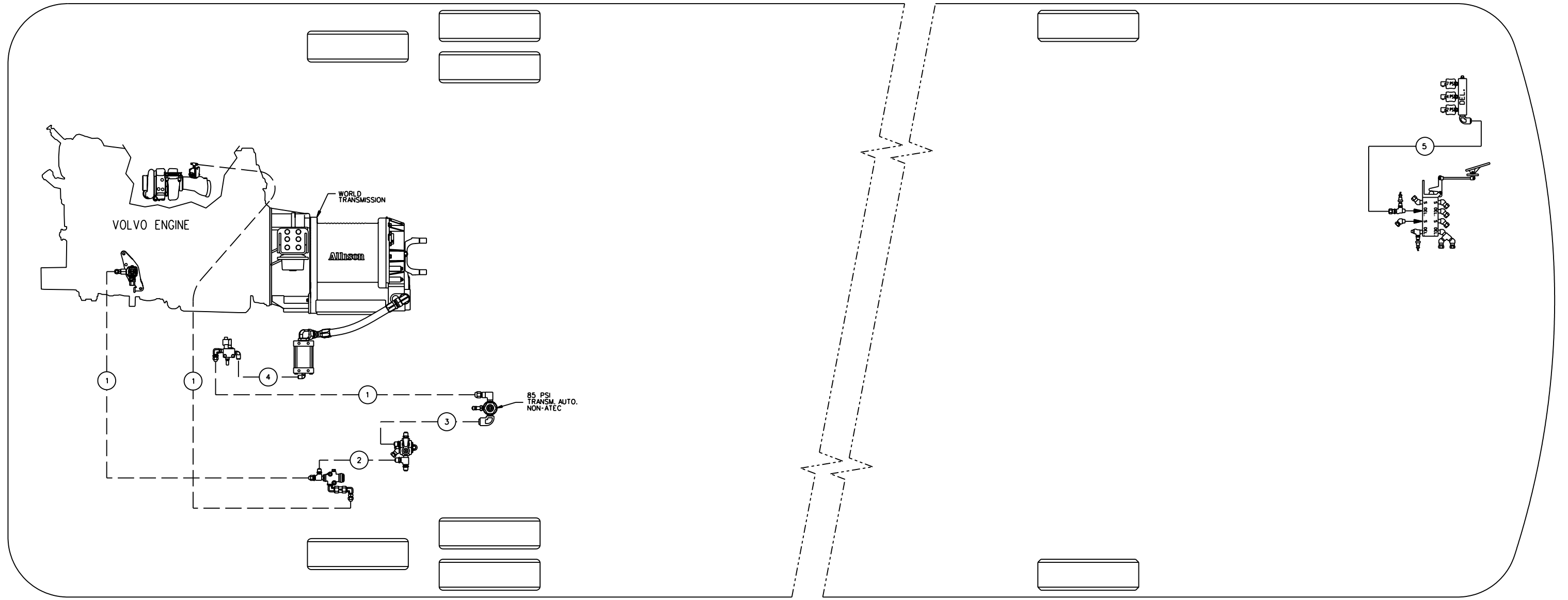

TUBE COLOR CODING		
ACTIVE	COLOR	CIRCUIT
---	BLACK	ACCESSORIES
---	GREEN	PRIMARY & SUPPLY

BALLOON	PIPE
*1	HOSE ASS'Y
*2	1/4" O.D. BLACK
*3	3/8" O.D. BLACK
*4	1/2" O.D. BLACK
*5	3/8" O.D. GREEN

**PREVOST**®

DESCRIPTION: X3-45 COACH, MD13 VOLVO ENGINE WITH INDEPENDENT FRONT SUSPENSION (I.F.S.) & OUTPUT RETARDER ON WORLD TRANSMISSION

EFF. W/ VEH : #8-9451...  
 DATE: 2008/06 REV.: A

PAGE: D140330 P12.1

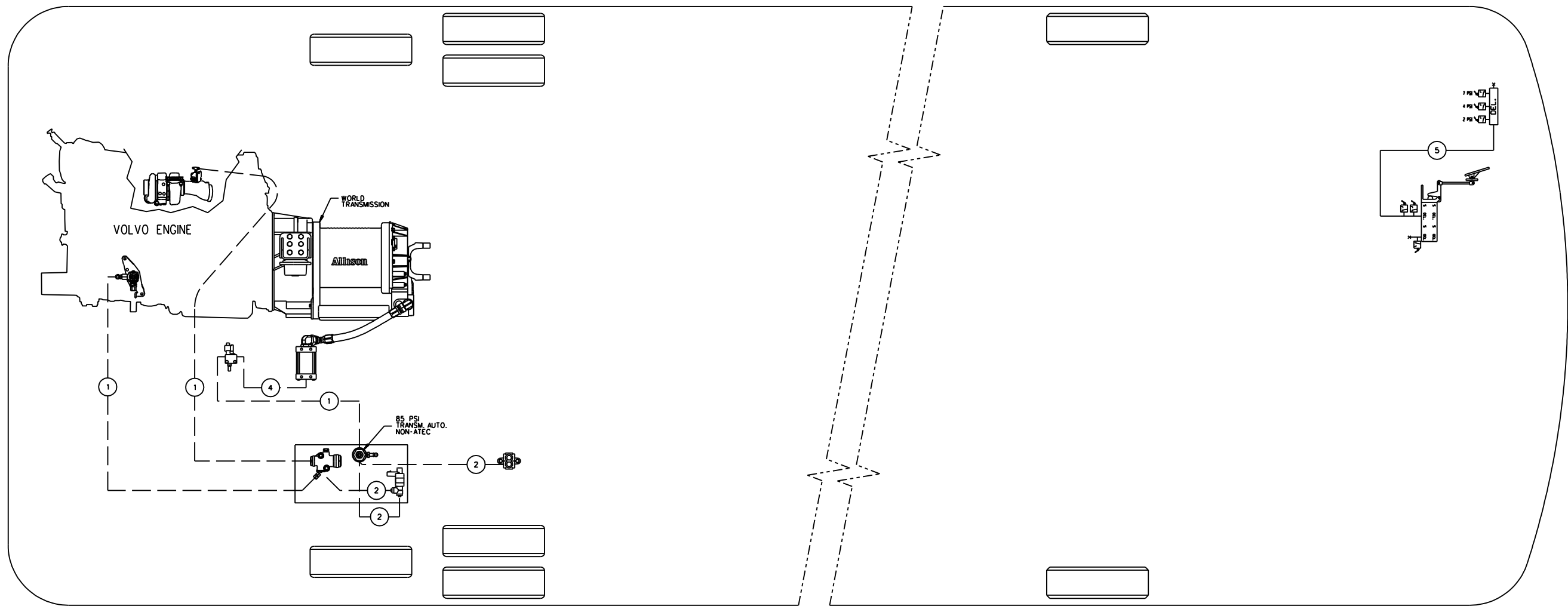

TUBE COLOR CODING		
ACTIVE	COLOR	CIRCUIT
---	BLACK	ACCESSORIES
---	GREEN	PRIMARY & SUPPLY

BALLOON	PIPE
*1	HOSE ASS'Y
*2	1/4" O.D. BLACK
*3	3/8" O.D. BLACK
*4	1/2" O.D. BLACK
*5	3/8" O.D. GREEN

**PREVOST**®

DESCRIPTION:

X3-45 COACH, MD13 VOLVO ENGINE  
WITH INDEPENDENT FRONT SUSPENSION (I.F.S.)  
& OUTPUT RETARDER ON WORLD TRANSMISSION

EFF. W/ VEH : #A-9953

DATE: 2010/04

REV.: B

PAGE:

D140330 P12.1

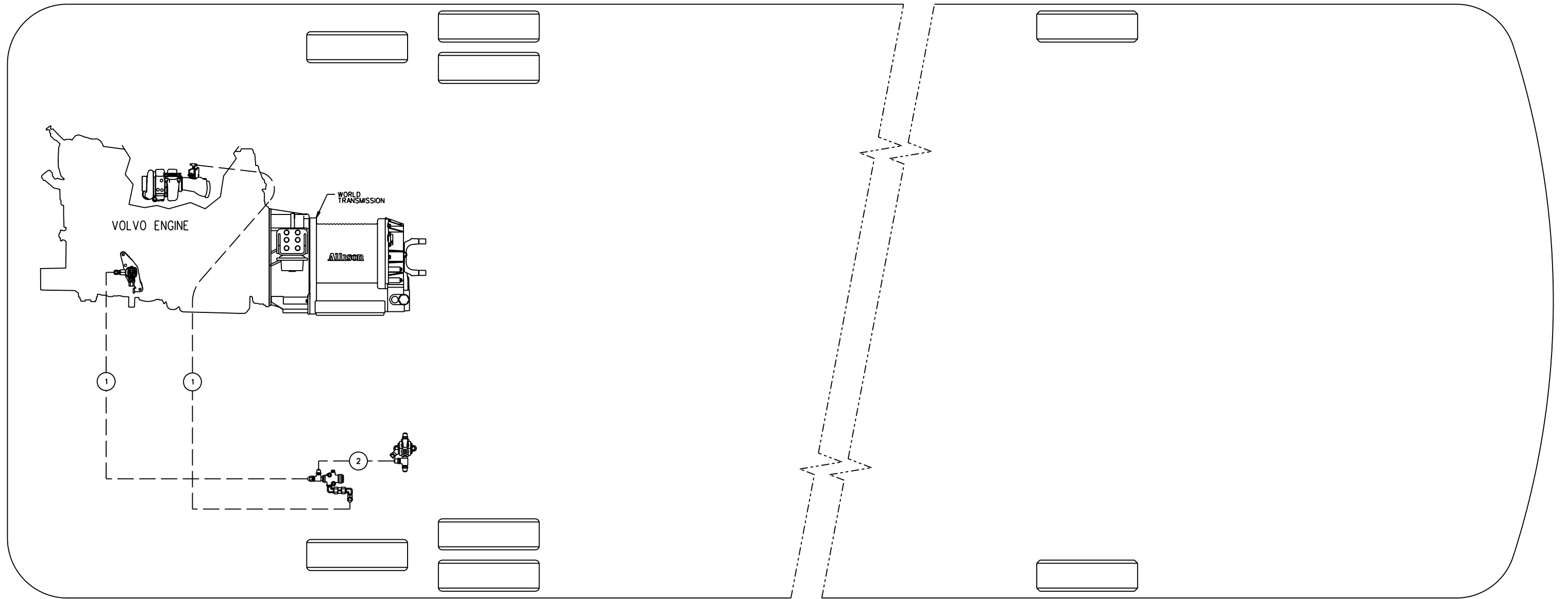

TUBE COLOR CODING		
ACTIVE	COLOR	CIRCUIT
---	BLACK	ACCESSORIES

BALLOON	PIPE
*1	HOSE ASS'Y
*2	1/4" O.D. BLACK

**PREVOST**®

DESCRIPTION: X3-45 COACH, MD13 VOLVO ENGINE  
WITH INDEPENDENT FRONT SUSPENSION (I.F.S.), WITHOUT  
OUTPUT RETARDER ON WORLD TRANSMISSION

EFF. W/ VEH : #8-9451...  
DATE: 2008/06

REV.: A

PAGE: D140330 P13.1

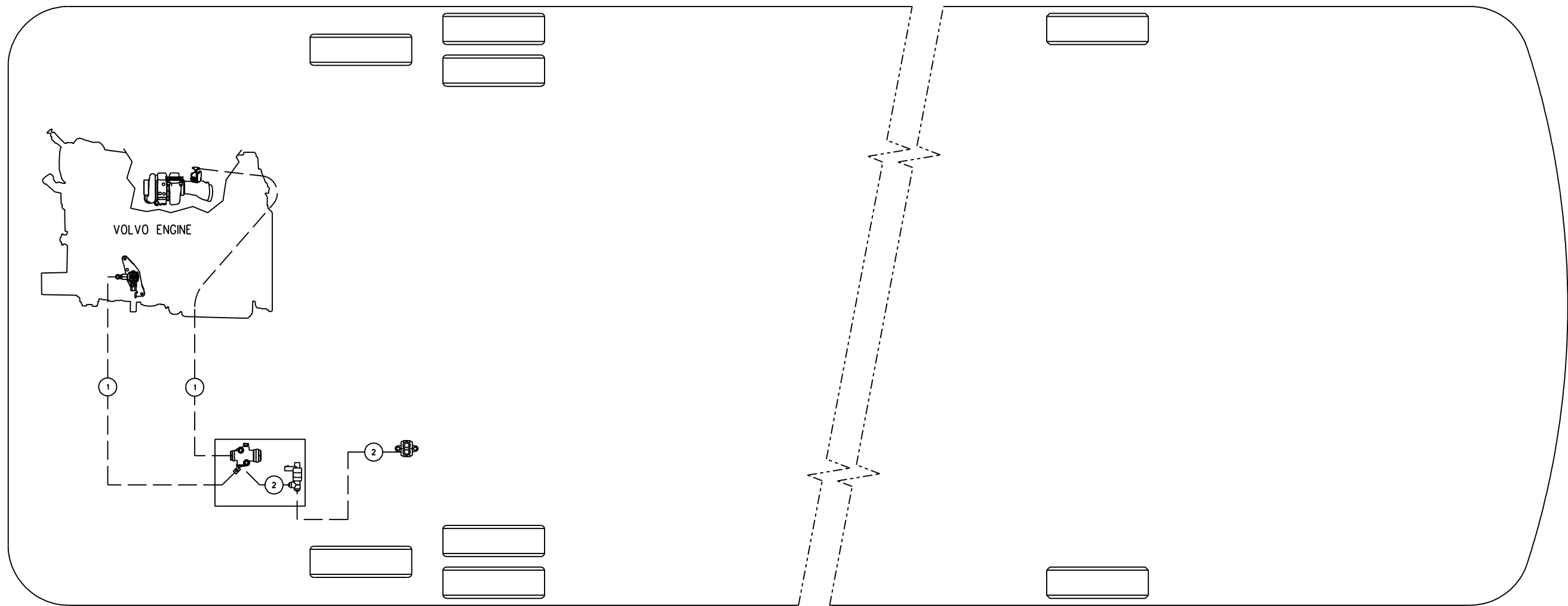

TUBE COLOR CODING	
ACTIVE	CIRCUIT
—	BLACK ACCESSORIES

BALLOON	PIPE
*1	HOSE ASS'Y
*2	1/4" O.D. BLACK

**PREVOST**®

DESCRIPTION: X3-45 COACH, MD13 VOLVO ENGINE WITH FRONT BEAM AXLE, WITHOUT OUTPUT RETARDER ON WORLD TRANSMISSION OR I-SHIFT

EFF. W/ VEH : #A-9953  
 DATE: 2010/04 REV.: B

PAGE: D140330 P13.1

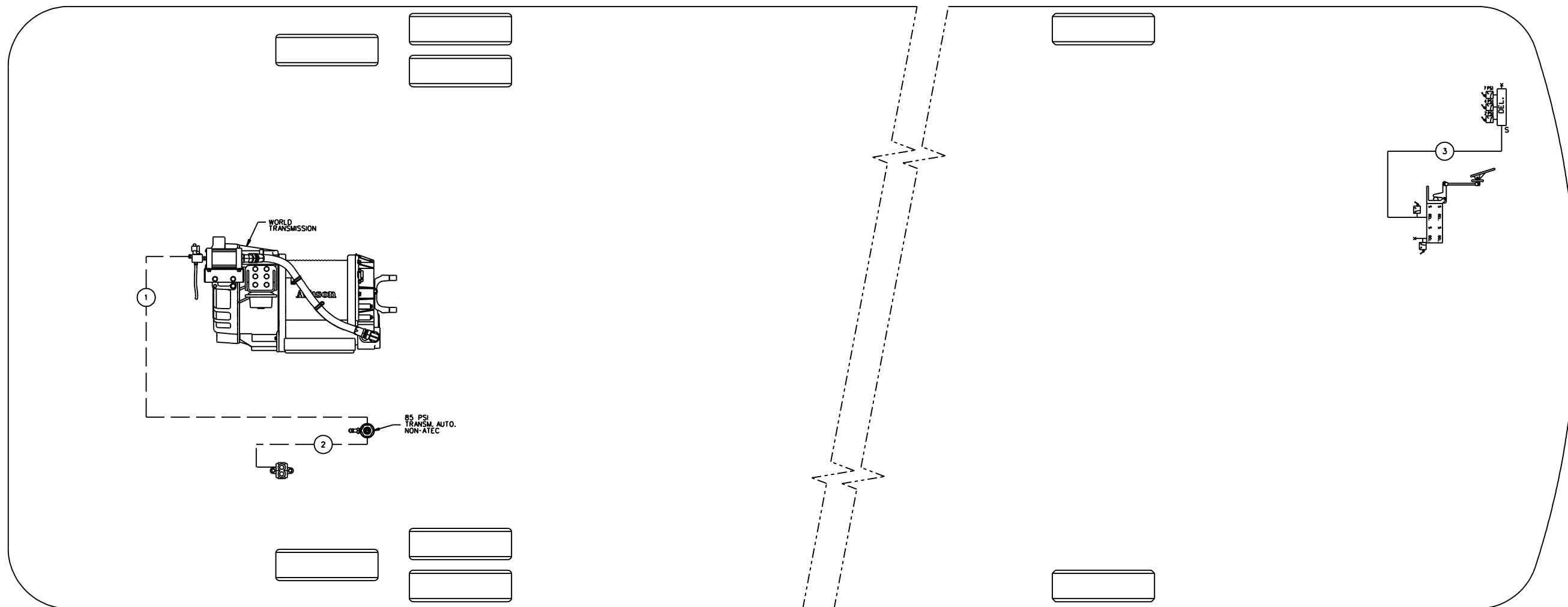

TUBE COLOR CODING		
ACTIVE	COLOR	CIRCUIT
---	BLACK	ACCESSORIES
---	GREEN	PRIMARY & SUPPLY

BALLOON	PIPE
*1	HOSE ASS'Y
*2	3/8" O.D. BLACK
*3	3/8" O.D. GREEN

**PREVOST**®

DESCRIPTION:

X3-45 COACH, WITH INDEPENDENT FRONT SUSPENSION (I.F.S.)  
S-60 WITH OUTPUT RETARDER ON WORLD TRANSMISSION

EFF. W/ VEH : #8-9282

PAGE:

D140330 P14.1

DATE: 2007/07

REV.: A

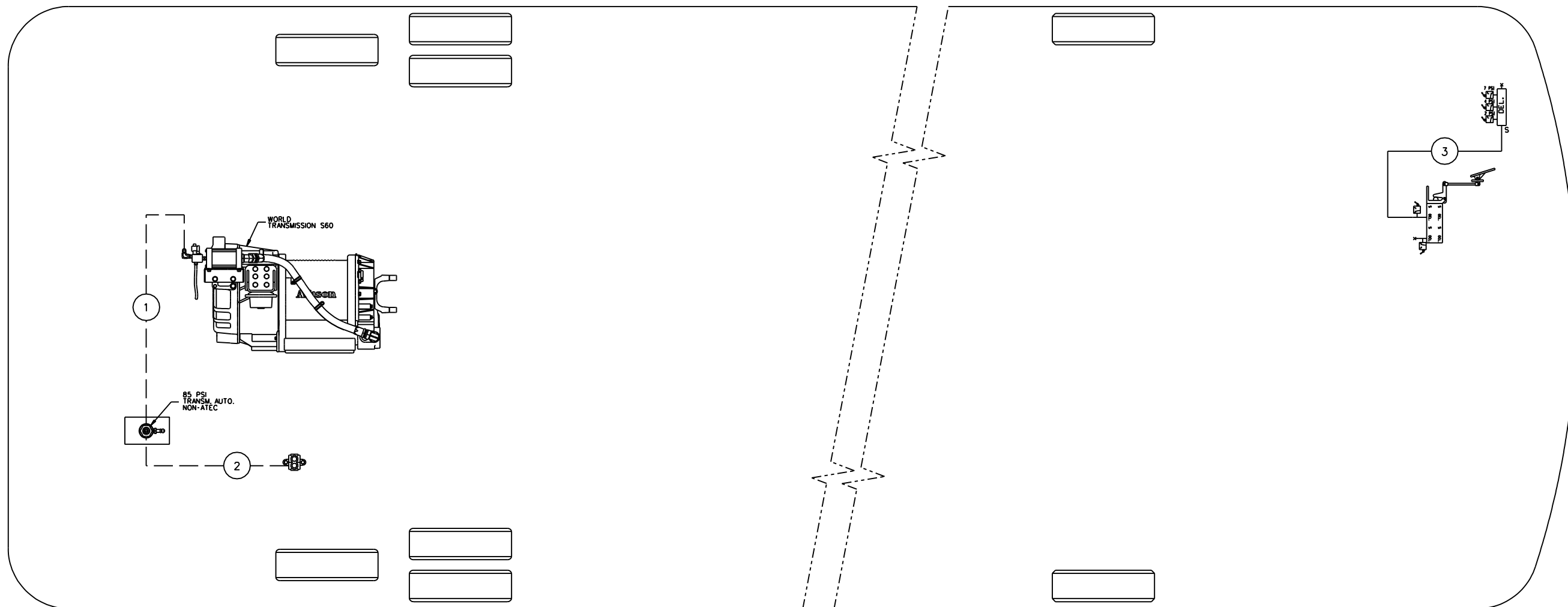

TUBE COLOR CODING		
ACTIVE	COLOR	CIRCUIT
---	BLACK	ACCESSORIES
---	GREEN	PRIMARY & SUPPLY

BALLOON	PIPE
*1	HOSE ASS'Y
*2	1/4" O.D. BLACK
*3	3/8" O.D. GREEN

**PREVOST**®

DESCRIPTION:

X3-45 COACH, WITH INDEPENDENT FRONT SUSPENSION (I.F.S.)  
WITH OUTPUT RETARDER ON WORLD TRANSMISSION S60

EFF. W/ VEH : #A-9953...

PAGE:

DATE: 2010/04

REV.: B

D140330 P14.1

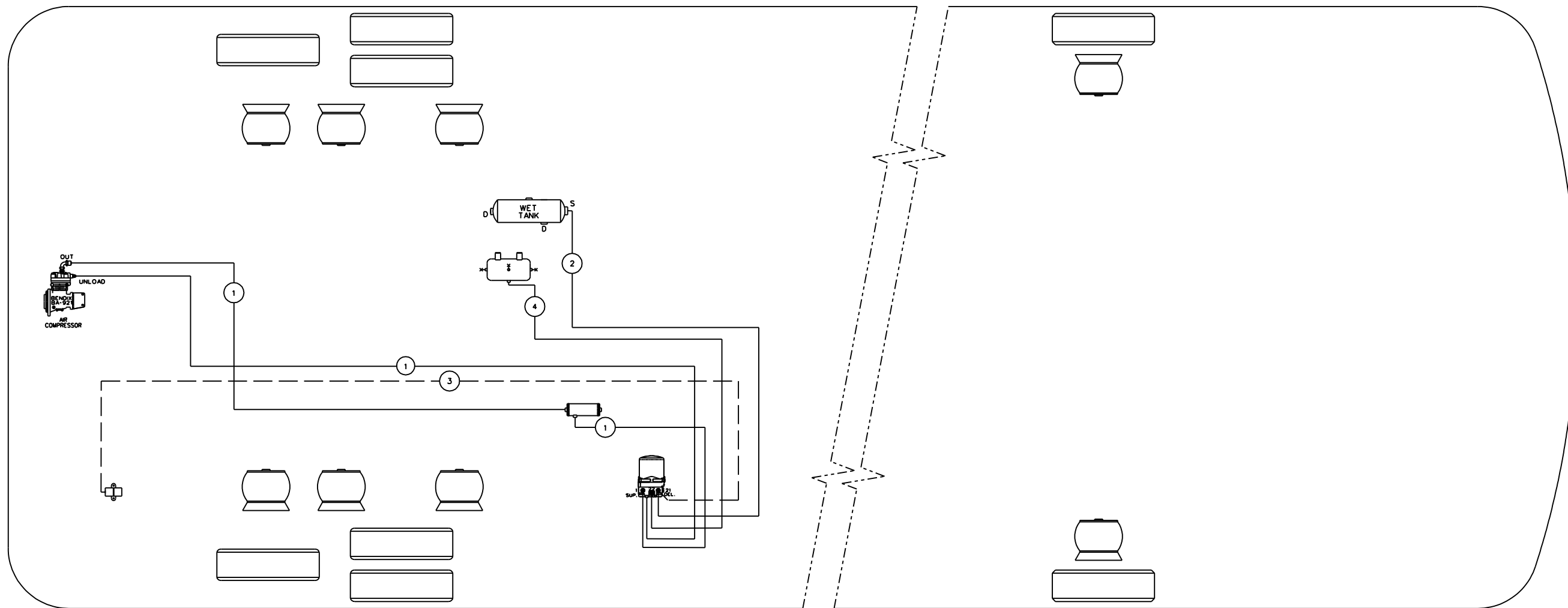

TUBE COLOR CODING	
ACTIVE COLOR	CIRCUIT
— GREEN	PRIMARY & SUPPLY
— BLACK	ACCESSORIES

BALLOON	PIPE
•1	HOSE ASS'Y
•2	3/4" O.D. GREEN
•3	1/4" O.D. BLACK
•4	3/8" O.D. GREY

**PREVOST**®

DESCRIPTION:

X3-45 COACH S60, WITH INDEPENDENT FRONT SUSPENSION (IFS)  
WITH HALDEX AIR DRYER REAR SUB FRAME OPTION

EFF. W/ VEH :

#A-9953

PAGE:

D140330 P15.1

DATE:

2010/04

REV.:

A